

DOOSAN



PUMA 2100/2600/3100 series

High Performance Horizontal Turning Center

PUMA 2100
PUMA 2600
PUMA 3100



**MACHINE
GREATNESS™**

Basic information

Basic Structure
Cutting
Performance

Detailed Information

Options
Applications
Capacity Diagram
Specifications

Customer Support Service



PUMA 2100/2600/3100 series

PUMA 2100/2600/3100 series has been developed to create full line up of high level 8" to 12" size with model variations from 2 axis to Y axis and sub spindle.

Contents

02 Product Overview

Basic Information

04 Basic Structure

09 Cutting Performance

Detailed Information

10 Standard / Optional Specifications

12 Applications

14 Capacity Diagram

18 Machine / CNC Unit Specifications

26 Customer Support Service



High Performance

These Doosan machines offer a high level of machining capability to provide optimum productivity for the customer.

Wide Variation

A wide variety of machine specifications from 2-axis models to turning centers with sub spindles is available to meet your production requirements.

Easy Operation

User-friendly operation panel configurations, EZ Guide i and EOP(Easy Operation Package) can make easy and comfortable to use various features of the product.

Basic Structure

Basic information

Basic Structure
Cutting
Performance

Detailed Information

Options
Applications
Capacity Diagram
Specifications

Customer Support Service

Box guideways are applied to all axes to prevent vibration, secure dynamic rigidity, and ensure powerful and precise machining.

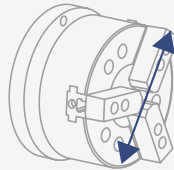
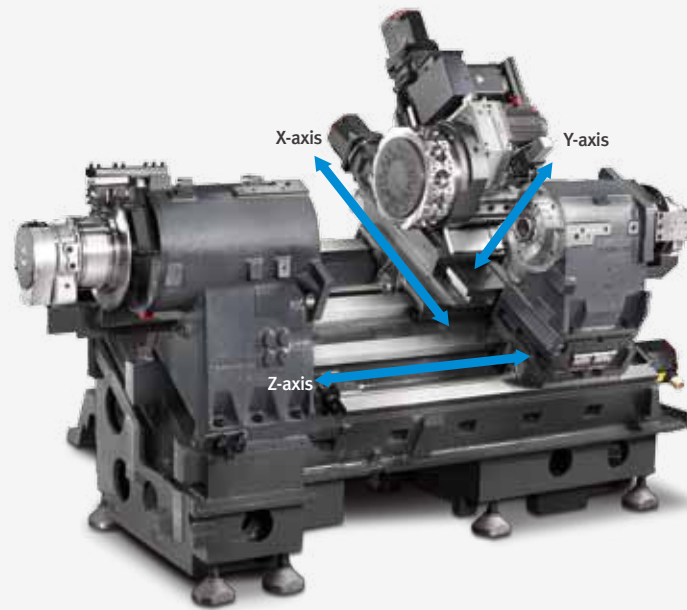

∅ 210 mm
(∅ 8.3 inch)

	PUMA 2100				2A / M / MS / Y / SY
	PUMA 2100L				2A / M / MS / Y / SY
Work length	520 (20.5)	760 (29.9)	1280 (50.4) mm (inch)	2125 (83.7)	3125 (123.0) mm (inch)

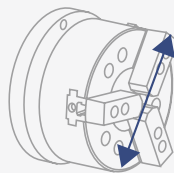

∅ 255 mm
(∅ 10 inch)

	PUMA 2600/500				2A / M
	PUMA 2600				2A / M / MS / Y / SY
	PUMA 2600L				2A / M / MS / Y / SY
Work length	520 (20.5)	760 (29.9)	1280 (50.4) mm (inch)	2125 (83.7)	3125 (123.0) mm (inch)

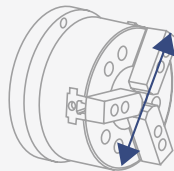

∅ 315 mm
(∅ 12.4 inch)

	PUMA 2600B				2A / M / S / MS / Y / SY
	PUMA 2600LB				2A / M / Y
	PUMA 3100				2A / M / Y
	PUMA 3100L				2A / M / Y
	PUMA 3100XL				2A / M / Y
	PUMA 3100UL				2A / M / Y
Work length	520 (20.5)	760 (29.9)	1280 (50.4) mm (inch)	2125 (83.7)	3125 (123.0) mm (inch)

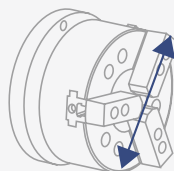

∅ 380 mm
(∅ 15 inch)

	PUMA 3100XLB				Y
	PUMA 3100ULB				Y
Work length	520 (20.5)	760 (29.9)	1280 (50.4) mm (inch)	2125 (83.7)	3125 (123.0) mm (inch)

High performance Y axis complex machining

Free operation in all directions of the rotary milling tool using Y axis control perform a variety of complex shape machining easily with high accuracy.

PUMA 2100 / 2600

105(±52.5)mm
(4.1 (±2.1) inch)

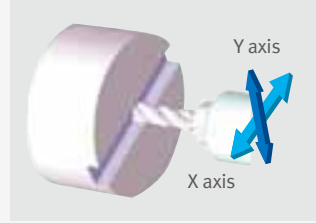

Groove finish cutting using the Y-axis



Multi-face cutting

PUMA 3100

130(±65)mm
(5.1 (±26) inch)

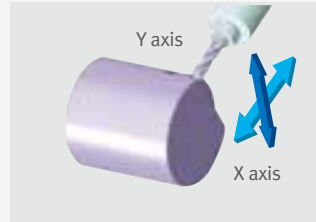

Milling in an eccentric position



Y & X axes circular interpolation

Machining area

These machines provide outstanding performance from general machining to large & long workpiece machining.

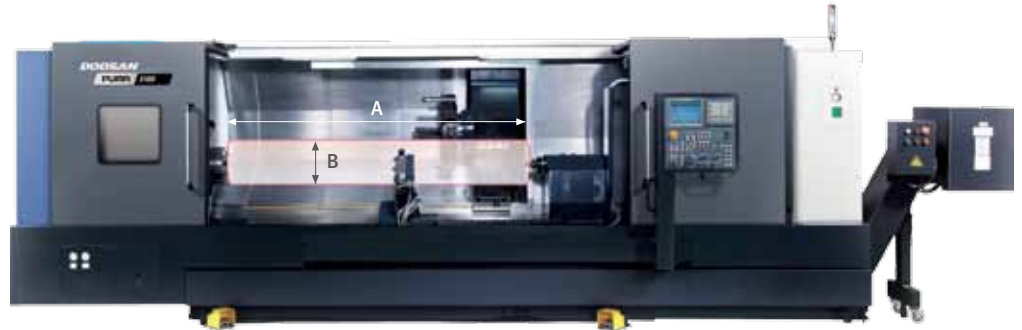

Unit : mm (inch)

Model	Max. turning length (A)	Max. turning dia. (B)
PUMA 2100	545 (21.4)	481 (18.9)
PUMA 2100M / MS / Y / SY	520 (20.5)	406 (16.0)
PUMA 2100L	785 (30.9)	481 (18.9)
PUMA 2100LM / LMS / LY / LSY	760 (29.9)	406 (16.0)
PUMA 2600	790 (31.1)	481 (18.9)
PUMA 2600M / MS / Y / SY	760 (29.9)	376 (14.8)
PUMA 2600L	1310 (51.6)	481 (18.9)
PUMA 2600LM / LMS / LY / LSY	1280 (50.4)	376 (14.8)
PUMA 2600/500	550 (21.7)	481 (18.9)
PUMA 2600M/500	520 (20.5)	376 (14.8)
PUMA 2600B / SB	755 (29.7)	481 (18.9)
PUMA 2600LB	1275 (50.2)	481 (18.9)
PUMA 2600MB / MSB / YB / SYB	725 (28.5)	376 (14.8)
PUMA 2600LMB / LYB	1245 (49.0)	376 (14.8)
PUMA 3100	790 (31.1)	525 (20.7)
PUMA 3100M / Y	765 (30.1)	420 (16.5)
PUMA 3100L	1310 (51.6)	525 (20.7)
PUMA 3100LM / LY	1285 (50.6)	420 (16.5)
PUMA 3100XL	2150 (84.7)	525 (20.7)
PUMA 3100XLM / XLY / XLYB	2125 (83.7)	420 (16.5)
PUMA 3100UL	3150 (124.0)	525 (20.7)
PUMA 3100ULM / ULY / ULYB	3125 (123.0)	420 (16.5)

Spindle

Basic information

Basic Structure
Cutting
Performance

Detailed Information

Options
Applications
Capacity Diagram
Specifications

Customer Support Service

Applying superior spindle motor & increase rigidity of headstock, to achieve stable performance during heavy & high speed machining.

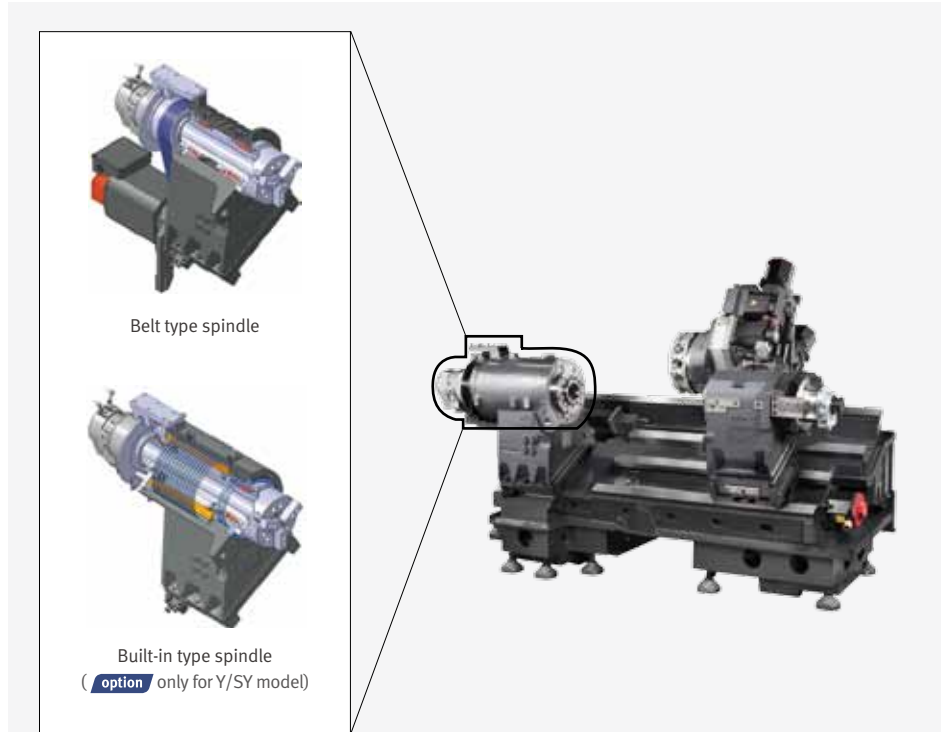

Model	Type	Max. speed r/min	Max. power kW (Hp)	Max. torque N-m (ft-lbs)
PUMA 2100	Belt	4500	18.5 (25)	183 (135)
PUMA 2600	Belt	3500	22 (30)	240 (177)
PUMA 2600B	Belt	2800	22 (30)	1123 (829)
PUMA 3100	Belt	2800	22 (30)	1123 (829)
	Built-in option	3000	30 (40)	1203 (888)
PUMA 3100B	Belt	2000	30 (40)	1611 (1188.9)

Sub spindle

Sub spindle function allow rear side cutting in a single setup.



Model	Type	Max. speed r/min	Max. power kW (Hp)	Max. torque N-m (ft-lbs)
PUMA 2100 / PUMA 2600	Belt	4500	7.5 (10)	85 (61)

Turret

Turret rotation is controlled by servo motor for fast and reliable tool selection. Doosan's unique BMT turret design is used on M and Y specification models to boost heavy duty milling performance.

2-axis model

PUMA 2100 / 2600

No. of tool stations

12st

PUMA 3100

No. of tool stations

10st
12st option



M,Y Model

PUMA 2100 : BMT 55P

PUMA 2600 / 3100 : BMT 65P

No. of tool stations

12st

Position index

12index
24index option



16st turret for Y axis model option

PUMA 2100 / 2600 : BMT 55P

No. of tool stations

16st

Position index

16index

Available Model

- PUMA 2100Y / LY / SY / LSY
- PUMA 2600Y / LY / SY / LSY



Rotary tool power-torque diagram

Max. power : 5.5 kW (7 Hp)

Max. speed : 5000 r/min

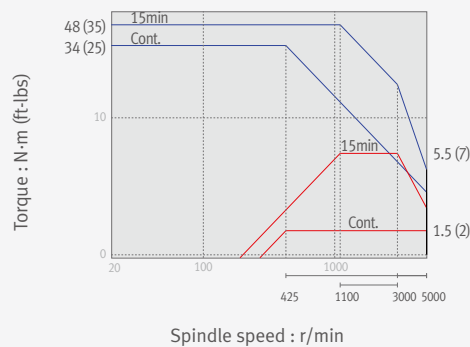

Rotary tool power-torque diagram option

Max. power : 7.5 kW (10 Hp)

Max. speed : 5000 r/min

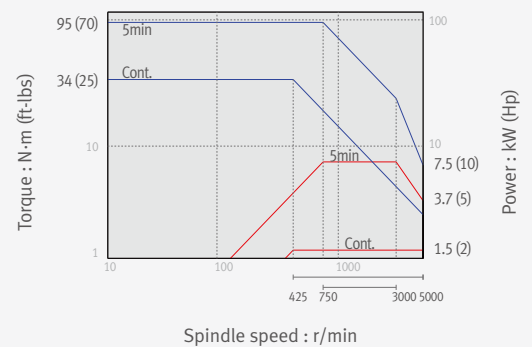



Tailstock

Basic information

Basic Structure
Cutting
Performance

Detailed Information

Options
Applications
Capacity Diagram
Specifications

Customer Support Service



High rigidity hydraulic tailstock is rigidly clamped to the bed slide way to provide stable support for long workpieces.



Tailstock type

- Manual
- Programmable
- Servo driven

Tailstock type

Tailstock type		PUMA 2100 / L series	PUMA 2600 / L series PUMA 3100 / L series	PUMA 3100XL / UL series
Manual 	Live center MT4	Standard	Not available	Not available
	Built-in center MT3	Option		
	Live center MT5	Not available	Standard	
	Built-in center MT4		Option	
Programmable 	Live center MT4	Option	Not available	Not available
	Built-in center MT3			
	Live center MT5	Not available	Option	
	Built-in center MT4			
	Built-in center MT5		Not available	
Servo driven 	Live center MT4	Option	Not available	Not available
	Built-in center MT3			
	Live center MT5	Not available	Option	
	Built-in center MT4			

Tailstock EZ function

In programmable tail stock, the Z-axis position of tail stock is recorded automatically as the clamped position of tail stock.



Cutting Performance

Multi-functionality including end milling, face milling, drilling, tapping, etc. offers better machining performance while minimizing work setting.

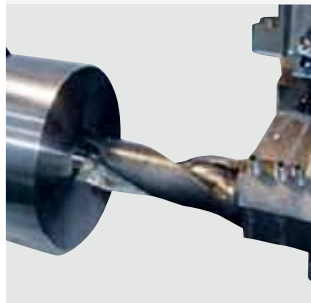
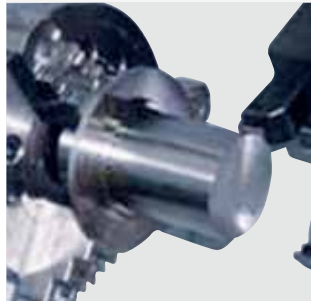
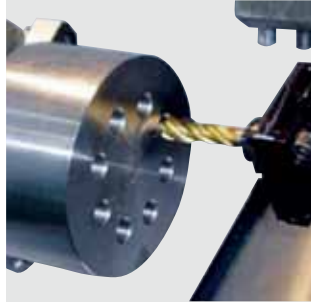
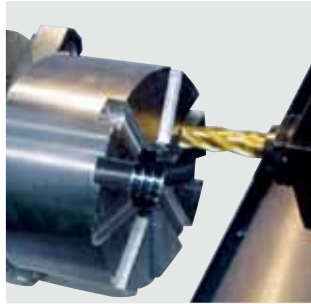

End mill		Carbon steel (SM45C)	
	Unit	PUMA 2100 BMT55P	PUMA 2600 BMT65P
Chip removal rate	cm ³ /min (inch ³ /min)	90 (35.43)	105 (41.34)
Tool Dia.	mm (inch)	18 (0.71)	20 (0.79)
Cutting Depth	mm (inch)	20 (0.79)	21 (0.83)
Feedrate	mm/min (ipm)	250 (9.8)	250 (9.8)

Tapping		Carbon steel (SM45C)	
	Unit	PUMA 2100 BMT55P	PUMA 2600 BMT65P
Rotary tool spindle speed	r/min	240	240
Tap Size		M20 x P2.5	M24 x P3
Feedrate	mm/min (ipm)	600 (23.6)	600 (23.6)

Face mill		Carbon steel (SM45C)	
	Unit	PUMA 2100 BMT55P	PUMA 2600 BMT65P
Chip removal rate	cm ³ /min (inch ³ /min)	41.9 (16.5)	53.9 (21.2)
Tool Dia.	mm (inch)	63 (2.5)	63 (2.5)
Cutting Depth	mm (inch)	3.5 (0.1)	4.5 (0.2)
Feedrate	mm/min (ipm)	190 (7.5)	190 (7.5)

O.D turning		Carbon steel (SM45C)	
	Unit	PUMA 2100 BMT55P	PUMA 2600 BMT65P
Chip removal rate	cm ³ /min (inch ³ /min)	528 (207.9)	616 (242.5)
Cutting Depth	mm (inch)	4.3 (0.2)	5.0 (0.2)
Feedrate	mm/rev (ipr)	0.55 (0.022)	0.55 (0.022)

U-Drill dia. (ø63 mm (2.5 inch))		Carbon steel (SM45C)	
	Unit	PUMA 2100	PUMA 2600
Chip removal rate	cm ³ /min (inch ³ /min)	472 (185.8)	630 (248.0)
Feedrate	mm/min (ipm)	0.15 (0.006)	0.2 (0.008)

Grooving		Carbon steel (SM45C)	
	Unit	PUMA 2100	PUMA 2600
Chip removal rate	cm ³ /min (inch ³ /min)	169 (66.54)	241 (94.9)
Cutting Depth	mm (inch)	8 (0.3)	8 (0.3)
Feedrate	mm/rev (ipr)	0.14 (0.006)	0.2 (0.008)

* The results, indicated in this catalogue are provides as example. They may not be obtained due to differences in cutting conditions and environmental conditions during measurement.



Standard / Optional Specifications

● Standard ○ Optional △: Pre-discussion is required X Not applicable

Basic information

Basic Structure
Cutting
Performance

Various options are available to satisfy the customers' requirements.

Detailed Information

Options
Applications
Capacity Diagram
Specifications

Customer Support Service

NO.	Description	PUMA 2100(L) / 2600(L)					PUMA 3100 Std./L			PUMA 3100 XL/UL		
		2-axis Std.	M	MS	Y	SY	2-axis Std.	M	Y	2-axis Std.	M	Y
1	Special chucks	△	△	△	△	△	△	△	△	△	△	△
2	Soft jaws	●	●	●	●	●	●	●	●	●	●	●
3	Dual pressure chucking	○	○	○	○	○	○	○	○	○	○	○
4	Hydraulic chuck pressure switch	○	○	○	○	○	○	○	○	○	○	○
5	Chuck clamp confirmation	○	○	○	○	○	○	○	○	○	○	○
6	Tail stock center : Live center	●	●	X	●	X	●	●	●	X	X	X
7	Tail stock center : Dead center	○	○	X	○	X	○	○	○	●	●	●
8	Tail stock : Manual	●	●	X	●	X	●	●	●	X	X	X
9	Tail stock : Programmable	○	○	X	○	X	○	○	○	●	●	●
10	Tail stock : Servo driven	○	○	X	○	X	○	○	○	X	X	X
11	Automatic quill advance & retract	○	○	X	○	X	○	○	○	○	○	○
12	Rotary tool holder	X	●	●	●	●	X	●	●	X	●	●
13	Tool setter : Manual	○	○	○	○	○	○	○	○	○	○	○
14	Tool setter : Automatic electric	○	○	○	○	○	○	○	○	○	○	○
15	Auto workpiece measurement	○	○	○	○	○	○	○	○	○	○	○
16	Linear scale (X-axis)	○	○	○	○	○	○	○	○	○	○	○
17	Linear scale (Z-axis)	○	○	○	○	○	○	○	○	○	○	○
18	Linear scale (Y-axis)	X	X	X	○	○	X	X	○	X	X	○
19	Feedback system : Absolute position encoder	●	●	●	●	●	●	●	●	●	●	●
20	Bar feeder interface	○	○	○	○	○	○	○	○	○	○	○
21	Bar puller	△	△	△	△	△	△	△	△	X	X	X
22	Workpiece ejector	X	X	○	X	○	X	X	X	X	X	X
23	Parts catcher with box	○	○	○	○	○	△	△	△	X	X	X
24	Parts catcher with conveyor	○	○	○	○	○	△	△	△	X	X	X
25	Workpiece cut off confirmation	X	X	○	X	○	X	X	X	X	X	X
26	Automatic front door : with safety device	○	○	○	○	○	○	○	○	○	○	○
27	Chip conveyor type : Right side	○	○	○	○	○	○	○	○	○	○	○
28	Chip conveyor type : Rear side *1	○	○	○	○	○	○	○	○	X	X	X
29	Chip bucket	○	○	○	○	○	○	○	○	○	○	○
30	TSC for main / left spindle	○	○	○	○	○	○	○	○	○	○	○
31	Oil skimmer	○	○	○	○	○	○	○	○	○	○	○
32	Coolant level switch : Sensing level - Low	○	○	○	○	○	○	○	○	○	○	○
33	Coolant chiller	○	○	○	○	○	○	○	○	○	○	○
34	Oil mist collector	○	○	○	○	○	○	○	○	○	○	○
35	Coolant blower	○	○	○	○	○	○	○	○	○	○	○
36	Air blower	○	○	○	○	○	○	○	○	○	○	○
37	Air gun	○	○	○	○	○	○	○	○	○	○	○
38	Signal tower (yellow, red, green)	○	○	○	○	○	○	○	○	○	○	○
39	Gantry loader	△	△	△	△	△	△	△	△	△	△	△
40	V-stand for shaft workpiece	○	○	X	○	X	○	○	○	X	X	X
41	Quick change tooling(CAPTO)	○	○	○	○	○	○	○	○	○	○	○
42	Sketch-turn S/W	○	○	○	○	○	○	○	○	○	○	○

*1 : PUMA 2100/L, PUMA 2600, PUMA 3100 only

* Please contact DOOSAN to select detailed steady rest specifications.

NO.	Description	PUMA 2100(L) / 2600(L)					
		2-axis Std.	M	MS	Y	SY	
43	MAIN SPINDLE TSC	○	○	○	SD17568-P2100 II-TSC (PUMA 2100Y II /LY II), SD18582-P2600 II-TSC (PUMA 2600Y II /LY II)	SD17568-P2100 II-TSC (PUMA 2100SY II/LSY II), SD18582-P2600 II-TSC (PUMA 2600SY II/LSY II)	
44	Customized Special Option	4JAW MAIN CHUCK	MHF208 (PUMA 2100/L/LS), MHF210 (PUMA 2600/L/LS)	MHF208 (PUMA 2100M/LM) / MHF210 (PUMA 2600M/LM)	MHF208 (PUMA 2100MS/LMS) / MHF210 (PUMA 2600MS/LMS)	MHF208 (PUMA 2100Y/LY/Y II /LY II) MHF210 (PUMA 2600Y/LY/Y II/LY II)	MHF208 (PUMA 2100SY/LSY/SY II/LSY II) MHF210 (PUMA 2600SY/LSY/SY II/LSY II)
45		WORKPIECE MEASUREMENT	OLP40 (PUMA 2100/L/LS, PUMA 2600/L/LS/B/LB/SB)	OLP40 (PUMA 2100M/LM, PUMA 2600M/LM/MB/LMB/M-500)	OLP40 (PUMA 2100MS/LMS, PUMA 2600MS/LMS/MSB)	OLP40 (PUMA 2100Y/LY/Y II/LY II, PUMA 2600Y/LY/Y II/LY II/YB II/LYB II)	OLP40 (PUMA 2100SY/LSY/SY II/LSY II/SYB II/LSYB II, PUMA 2600SY/LSY/SY II/LSY II)
46	BEAM SENSOR TYPE SAFETY SWITCH	KEYENCE (PUMA 2600B/LB/SB)	KEYENCE (PUMA 2600MB/LMB)	KEYENCE (PUMA 2600MSB)	○	○	

NO.	Description	PUMA 3100 / L			PUMA 3100 XL/UL		
		2-axis Std.	M	Y	2-axis Std.	M	Y
43	MAIN SPINDLE TSC	○	○	○	○	○	○
44	4JAW MAIN CHUCK	○	○	○	○	○	○
45	WORKPIECE MEASUREMENT	OLP40 (PUMA 3100/L/XL/UL)	OLP40 (PUMA 3100M/LM/XLM/ULM)	OLP40 (PUMA 3100Y/LY/XLY/ULY)	○	○	OLP40 (PUMA 3100XLYB/ULYB)
46	BEAM SENSOR TYPE SAFETY SWITCH	○	○	○	○	○	○

Steady rest

High pressure coolant

○ Optional X Not applicable

Steady Rest	PUMA 2100			PUMA 2600			PUMA 3100		
	Std.	L	XL/UL	Std.	L	XL/UL	Std.	L	XL/UL
Type	Hydraulic	○	○	○	○	○	○	○	○
	Programmable	○	○	○	○	○	○	○	○
	Servo driven*1	X	X	X	X	X	X	X	○
	SLU-1	○	○	○	○	○	X	X	X
	SLU-2	○	○	○	○	○	○	○	○
	SLU-B3.1	X	○	○	○	X	X	X	X
Size	SLU-3.1	X	X	X	X	○	○	○	○
	SLU-3.2	X	X	X	X	X	X	○	○
	SLU-4	X	X	X	X	X	X	○	*2
	SLU-B4	X	X	X	X	X	X	○	○

Model	PUMA 2100 / 2600 / 3100			
		60Hz	50Hz	
Standard	1.5 bar	0.4 kW x 0.15 MPa x 40 L/min	0.4 kW x 0.15 MPa x 40 L/min	
	5 bar	0.9 kW x 0.45 MPa x 30 L/min	0.9 kW x 0.30 MPa x 30 L/min	
option	7 bar	1.5 kW x 0.7 MPa x 30 L/min	1.5 kW x 0.5 MPa x 30 L/min	
	10 bar*	2.2 kW x 1.0 MPa x 30 L/min	2.2 kW x 0.7 MPa x 30 L/min	
	15 bar*	3.7 kW x 1.45 MPa x 30 L/min	4.0 kW x 2.8 MPa x 20 L/min	
	28 bar*	4.0 kW x 2.8 MPa x 20 L/min	4.0 KW X 1.95MPa X 20 L/min	
Special option	70 bar*	5.5 kW x 7.0 MPa x 30 L/min	5.5 kW x 7.0 MPa x 26 L/min	

*1 : Rack & Pinion type.

*2 : SLU-4 is not available in servo driven type.

* Recommend using coolant chiller

Peripheral equipments

Oil skimmer option



The oil skimmer keeps coolant and lubricant isolated from each other for extending lifecycle of coolant.

Tool setter option



The tool setter facilitates setting of tools, and fast and precise length compensation of abraded tool.

Part catcher option



The part catcher automatically accepts parts completed of machining, and ejects them out of the system.

Coolant chiller option

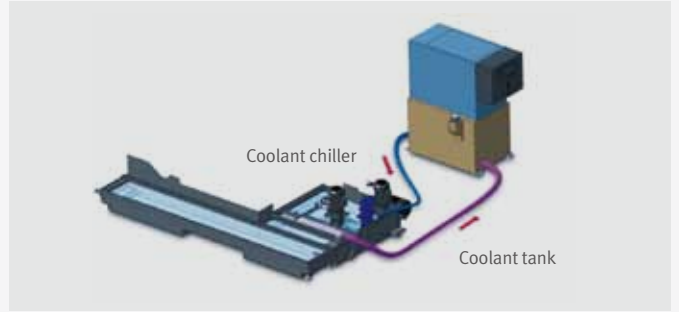

Detachable coolant chiller is recommended to keep thermal error minimal and get higher machining precision.

Mist collector option



The mist collector absorbs airborne oil vapor and fine dusts in the system to improve working environment.

Collet chuck option

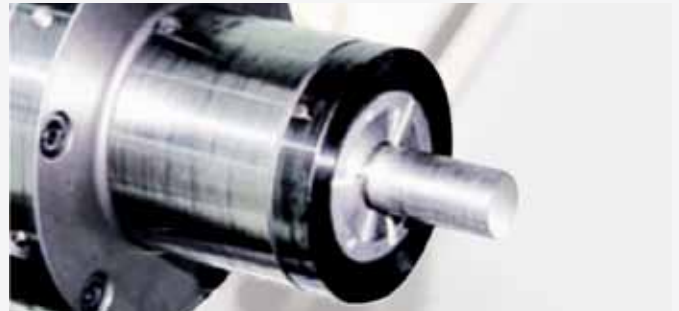

The collet chuck is ideal for loading workpiece of small diameter and light weight.

Coolant Blower option



Signal tower option



Quick change CAPTO option



The Quick Change Tool system simplifies tool change operation. Recommended for users who need to change tools frequently or reduce the set-up time.

DOOSAN Fanuc i Plus

15 inch screen + New OP

DOOSAN Fanuc i Plus' operation panel enhances operating convenience by incorporating common-design buttons and layout, and features the Qwerty keyboard for fast and easy operation.

Basic information

- Basic Structure
- Cutting
- Performance

DOOSAN Fanuc i Plus is optimized for maximizing customer productivity and convenience.

Detailed Information

- Options
- Applications
- Capacity Diagram
- Specifications

Customer Support Service



DOOSAN Fanuc i Plus

- 15 inch color display
- Intuitive and user-friendly design

USB & PCMCIA card QWERTY keyboard

- EZ-guide i standard
- Ergonomic operator panel
- 2MB Memory
- Hot key

iHMI Touch screen option

- iHMI provides an intuitive interface that utilizes a touch screen for quick and easy operation

Variety of applications

- Providing various applications related to PLANNING, MACHINING, IMPROVEMENT, and UTILITY for customer convenience.

EZ-Guide i

Using the DOOSAN EZ-Guide i, users can create a cutting program for any desired shape, including patterns, by entering figures only.

Example programming

Cutting shape

EZ-Guide i screen

Enter the dimensions of the shape.

Automatic creation of cutting program

```

O7000 (SAMPLE PROGRAM) ;
...
M3 S1500 ;
G0 X50. Y125. ;
G0 Z30. ;
G1040 T0.5 J3. H0.2 K0.5 ... ;
G1020 H120. V50. U37. W68. ... ;
G0 Z80. ;
M5 ;

```

A cutting program is automatically created with the entered values.

Improve productivity

Reduced non-cutting cycle time

10 %

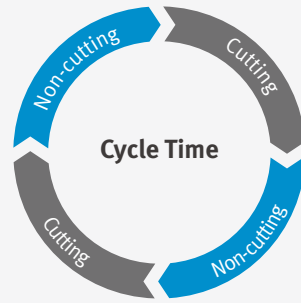

Non-cutting time during machining process is dramatically reduced to guarantee the highest productivity.

Easy operation package

G code / M code



G code / M code help function provides code number and description to view.

Calculator



Calculator function provides a variety of calculations which are arithmetic, hole, arc, machining condition.

Turret recovery



Screen with recovery information about turret malfunction.

Operation rate



Function allows users to easily keep track of machine operating hours and the number of completed parts.

Tool load monitoring



This function detects overload on tools, caused by wear and damage, and triggers an alarm to minimize damage.

Tail stock thrust force setting option

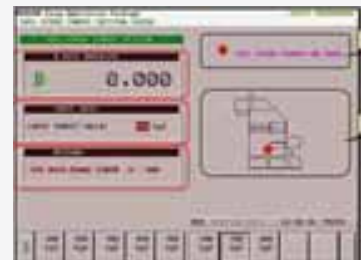

This function allows users to easily setup tailstock thrust force on the screen.

SKETCH-TURN option



DOOSAN Conversational programming software for PC

- Easy to learn for beginners
- Time savings in programming
- Reduce processing cycle time

Product Preview



SIEMENS S828D

15.6 inch screen + New OP

The newly-designed operation panel enhances operating convenience by incorporating common-design buttons and layout, and features the Qwerty keyboard for fast and easy operation.

Basic information

Basic Structure
Cutting
Performance

SIEMENS CNC optimized for DOOSAN machine tools maximizes users' productivity.

Detailed Information

Options
Applications
Capacity Diagram
Specifications

Customer Support Service



Conversational Convenient function

The machining monitoring function developed on the basis of the Shop Turn – an interactive machining support function of SIEMENS – provides users with cutting, servicing and maintenance screens for easy and convenient machine operation.

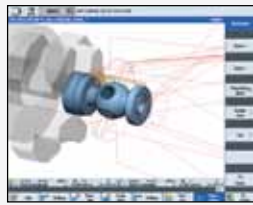

Cutting and operation support function

This function shows a cutting and tool path simulation of a cutting program on a real-time basis.

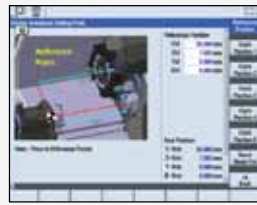

Operation safety function

Spindle and Turret's interference could be checked before crash. So that it Protect operator's mistake.
[offset] [operating parameter] [attachment setting] [Collision avoidance]



Maintenance and service convenience function

Maintenance and service of major units and peripheral devices, timer setting and parts counter setting can be easily carried out on a convenient screen.
[offset] [operating parameter] [TC service]

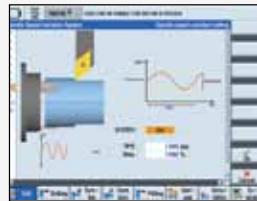

Machining accuracy improvement

The NC controls spindle speed at an optimal level for precision threading and turning, making it possible to improve surface roughness automatically.
[various] [attachment] [DSSV]



Before applying the function



After applying the function

Spindle power-torque diagram (SIEMENS)

PUMA 2100

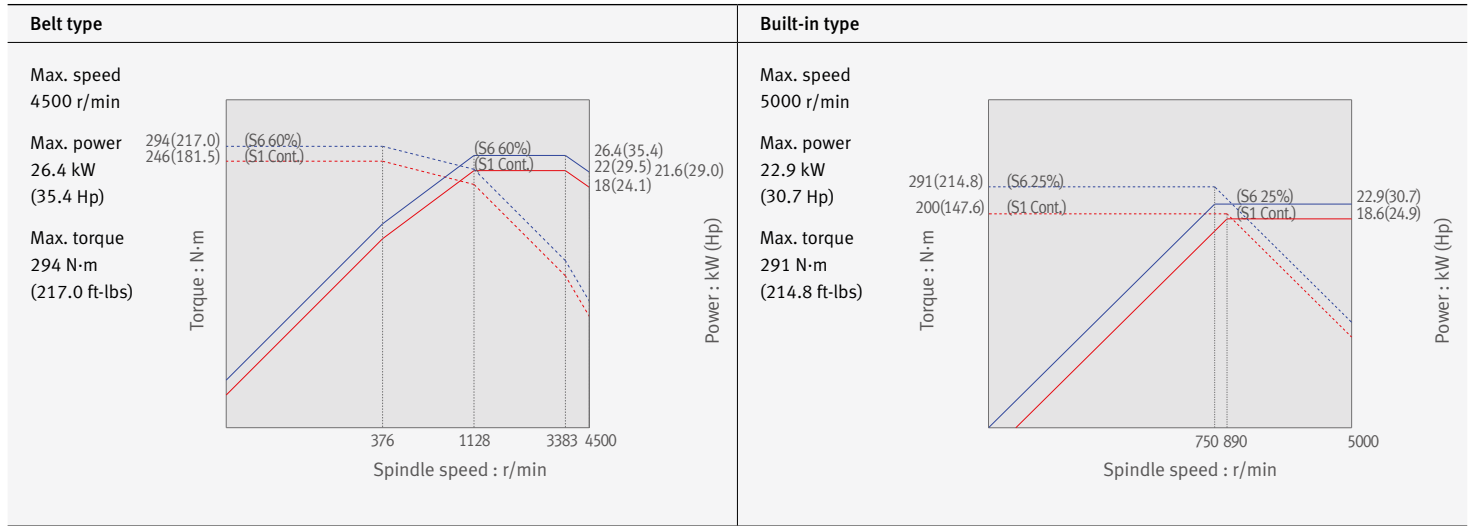

PUMA 2600

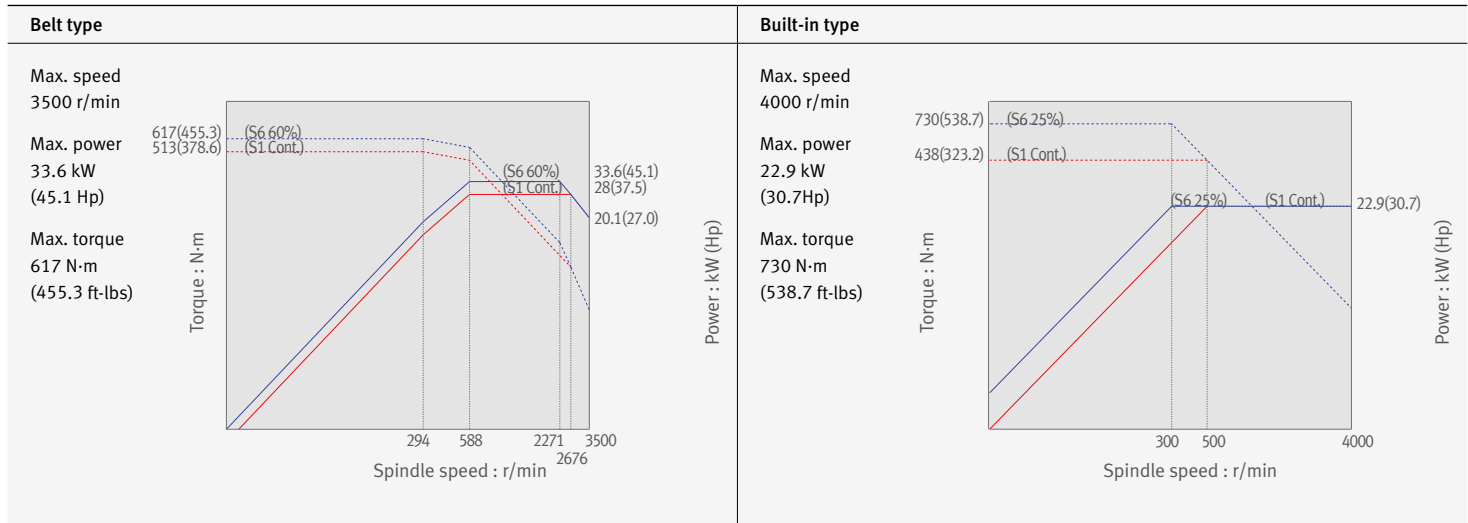

PUMA 3100

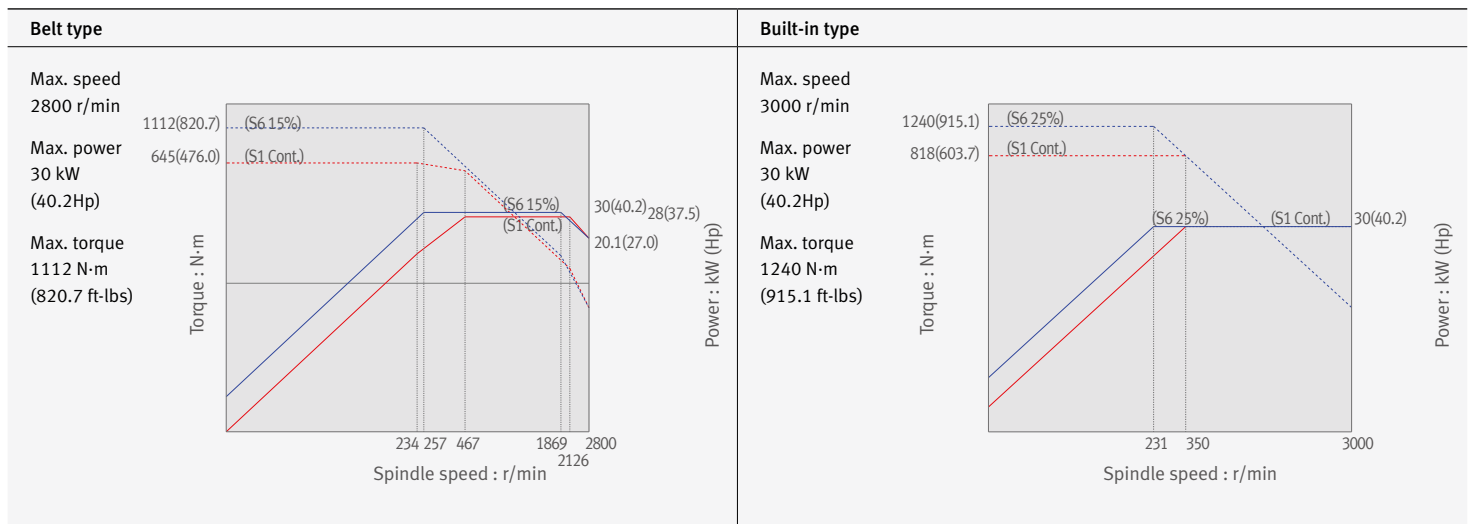

Spindle power-torque diagram

Basic information

Basic Structure
Cutting
Performance

Detailed Information

Options
Applications
Capacity Diagram
Specifications

Customer Support Service

PUMA 2100 series

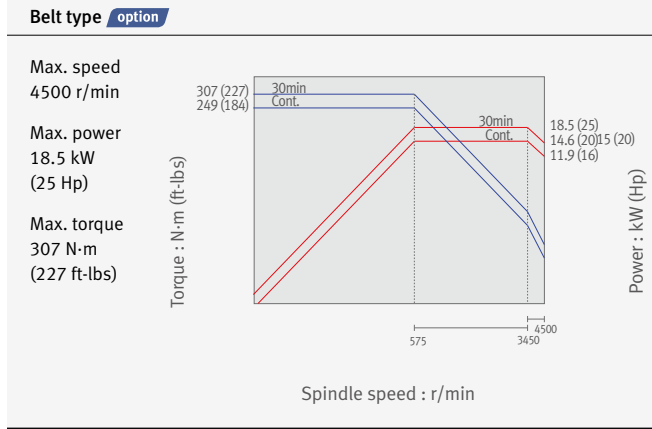
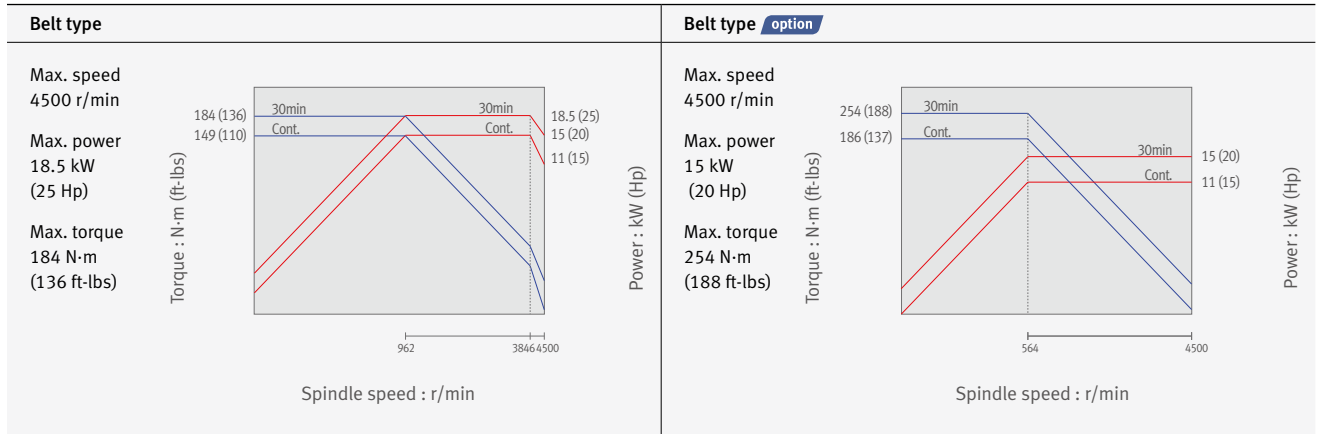

PUMA 2600 series

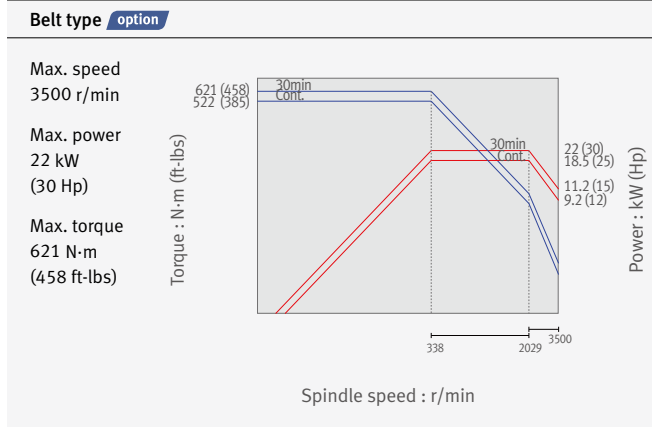
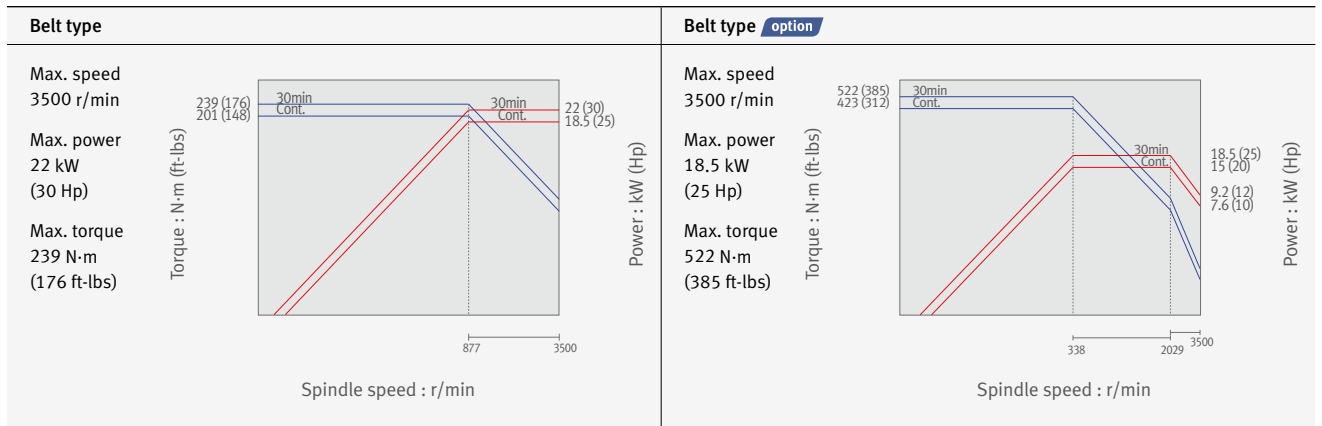

Spindle power-torque diagram

PUMA 2600 / 500, PUMA 2600M / 500

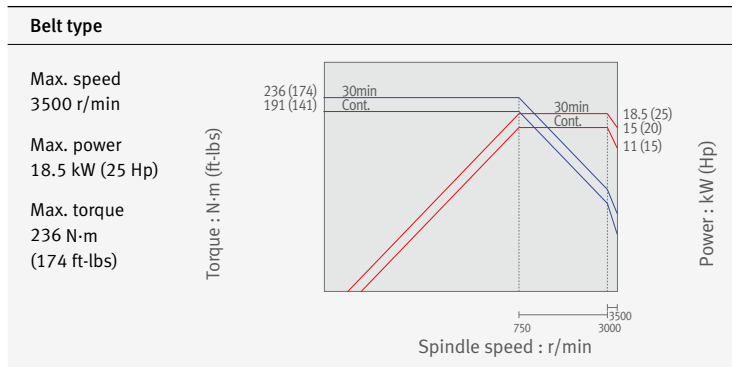

PUMA 2600B / 3100 series

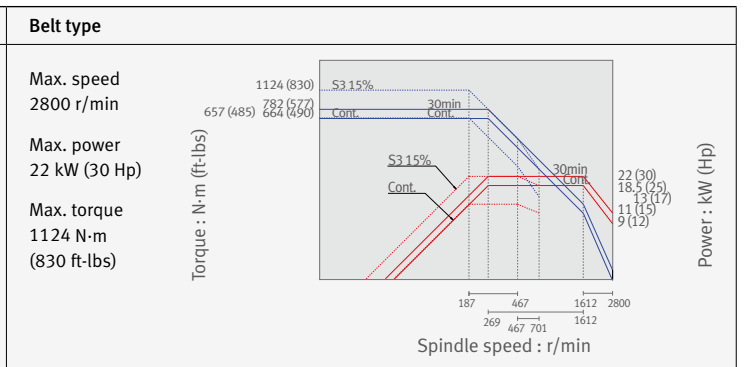

PUMA 2600B / 3100 series

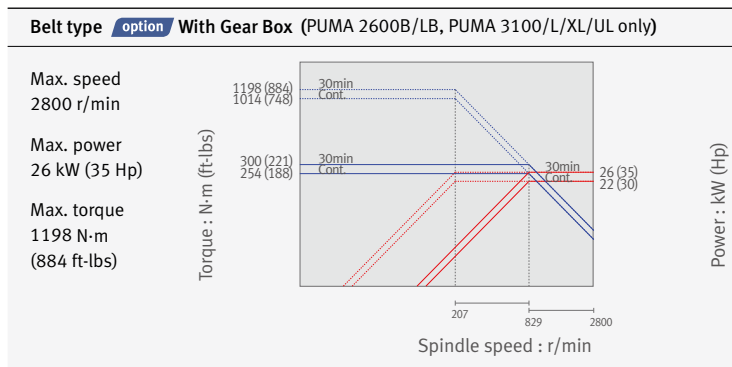

PUMA 3100 series

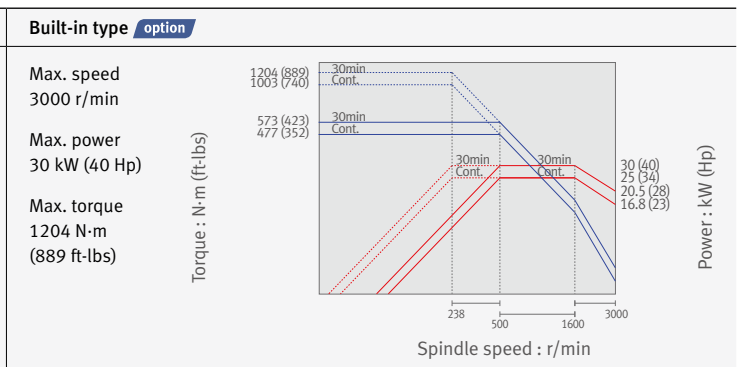

PUMA 3100 XL/UL

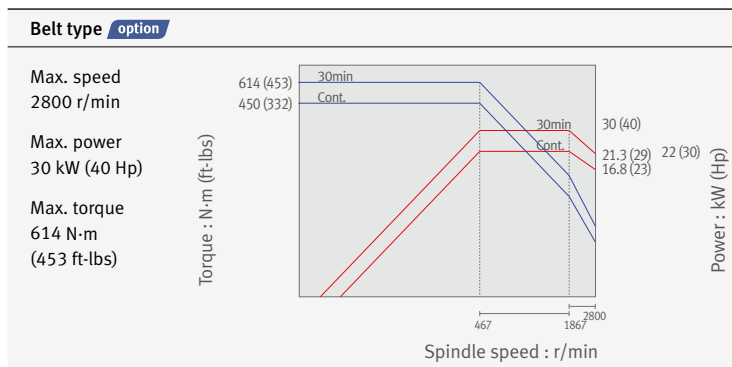

PUMA 3100 XLYB/ULYB

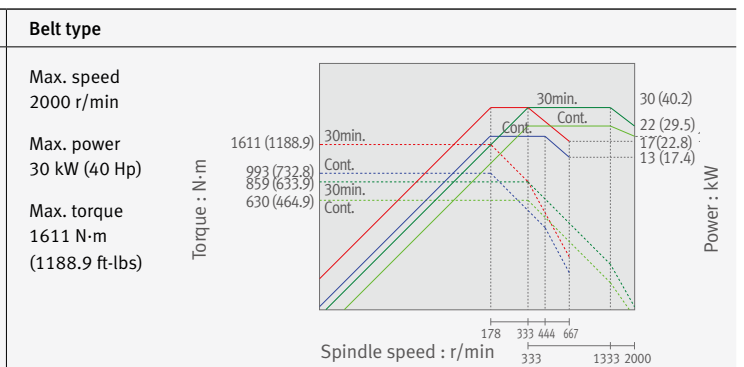

Sub spindle power-torque diagram

PUMA 2100 / 2600

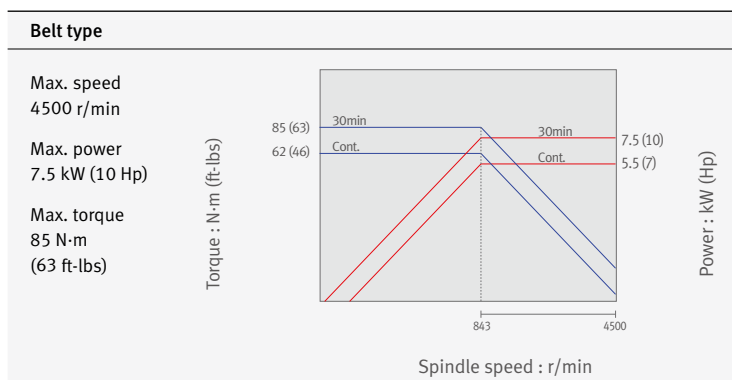

External Dimensions

Basic information

- Basic Structure
- Cutting
- Performance

Detailed Information

- Options
- Applications
- Capacity Diagram
- Specifications

Customer Support Service

PUMA 2100 / 2600

Unit : mm (inch)

Top view

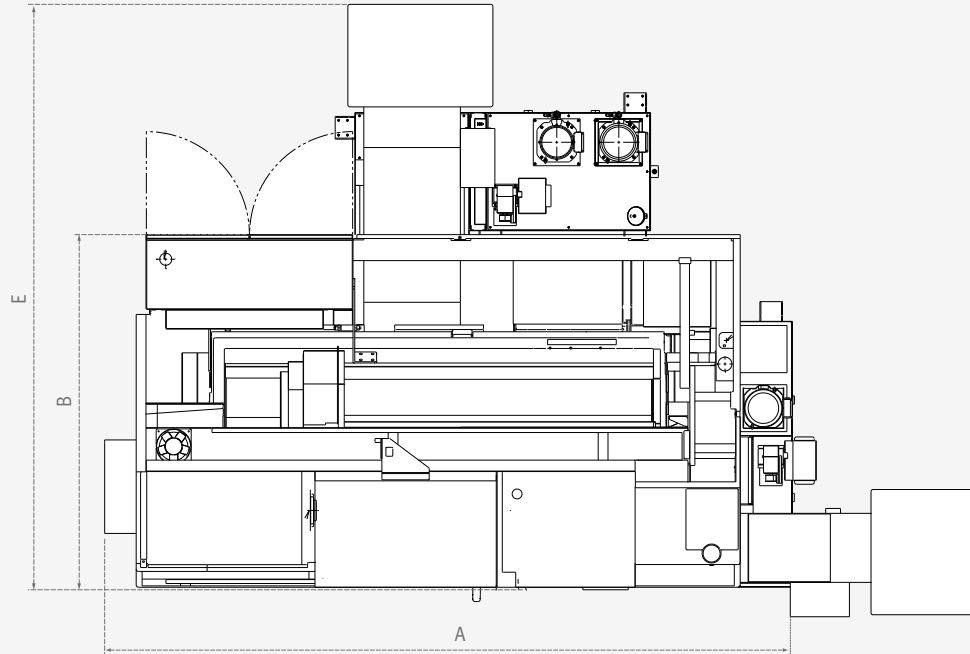

Front view

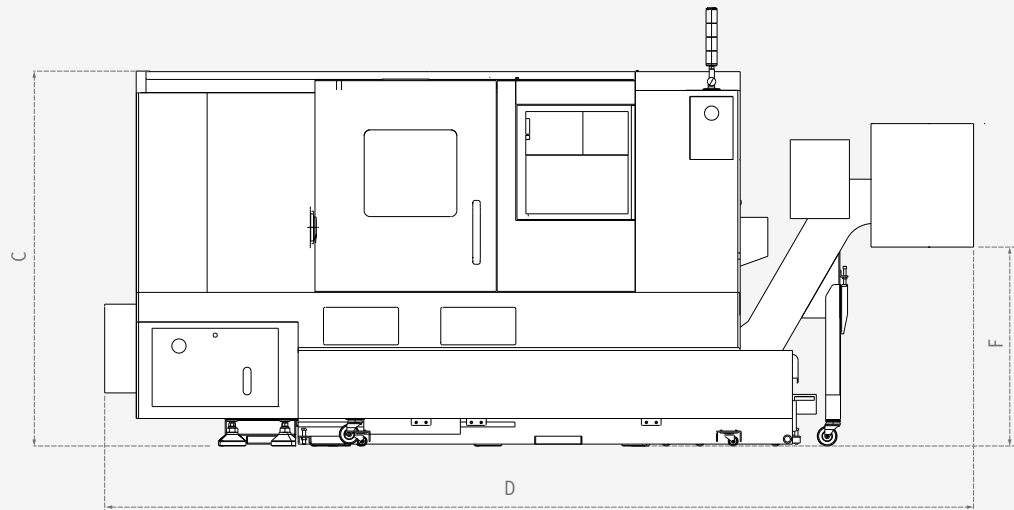

Model	A (Length)	B (Width)	C (Height)	D (Length with side chip conveyor)	E (Width with rear chip conveyor)	F (Height of ground to chip outlet)
PUMA 2100	3415 (134.4)	1863 (73.3)	1900 [2163] (74.8 [85.2])	4190 (165.0)	3032 (119.4)	1010 (39.8)
PUMA 2100L	3530 (139.0)	1863 (73.3)	1900 [2163] (74.8 [85.2])	4410 (173.6)	3032 (119.4)	1010 (39.8)
PUMA 2600/500	3415 (134.4)	1863 (73.3)	1900 (74.8)	4260 (167.7)	3032 (119.4)	1010 (39.8)
PUMA 2600	3600 (141.7)	1863 (73.3)	1900 [2163] (74.8 [85.2])	4480 (176.4)	3032 (119.4)	1010 (39.8)
PUMA 2600L	4335 (170.7)	1965 (77.4)	1900 [2163] (74.8 [85.2])	5389 (212.2)	-	1010 (39.8)
PUMA 2600B	3873 (152.5)	1863 (73.3)	1900 (74.8)	4753 (187.1)	3032 (119.4)	1010 (39.8)
PUMA 2600LB	4438 (174.7)	1965 (77.4)	1900 (74.8)	5492 (216.2)	-	1010 (39.8)

PUMA
2100/2600/3100
series

* Some peripheral equipment can be placed in other places

External Dimensions

PUMA 3100XL

Unit : mm (inch)

Top view

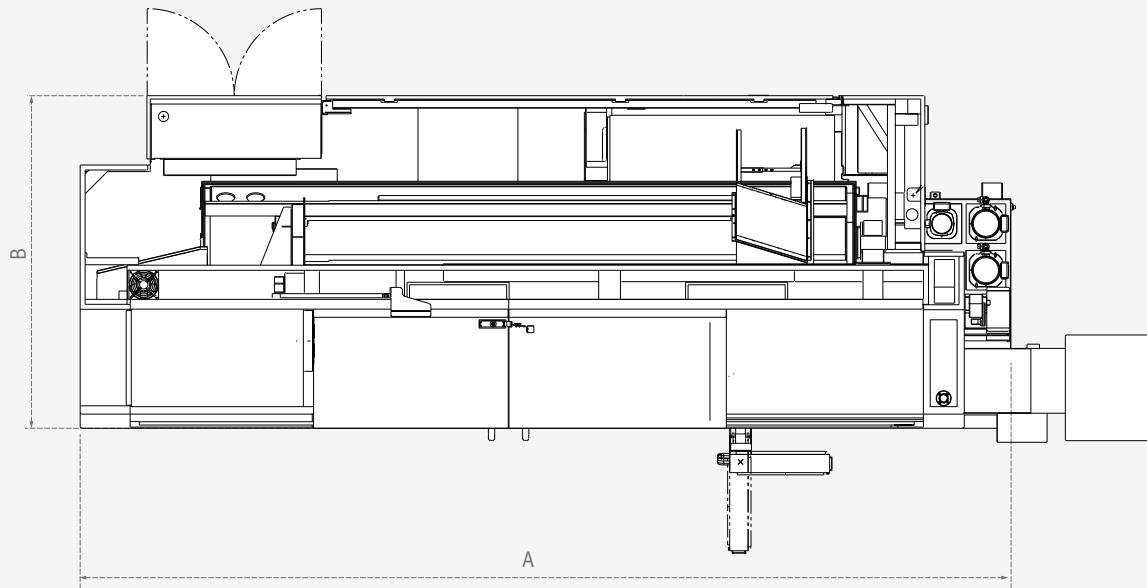

Front view

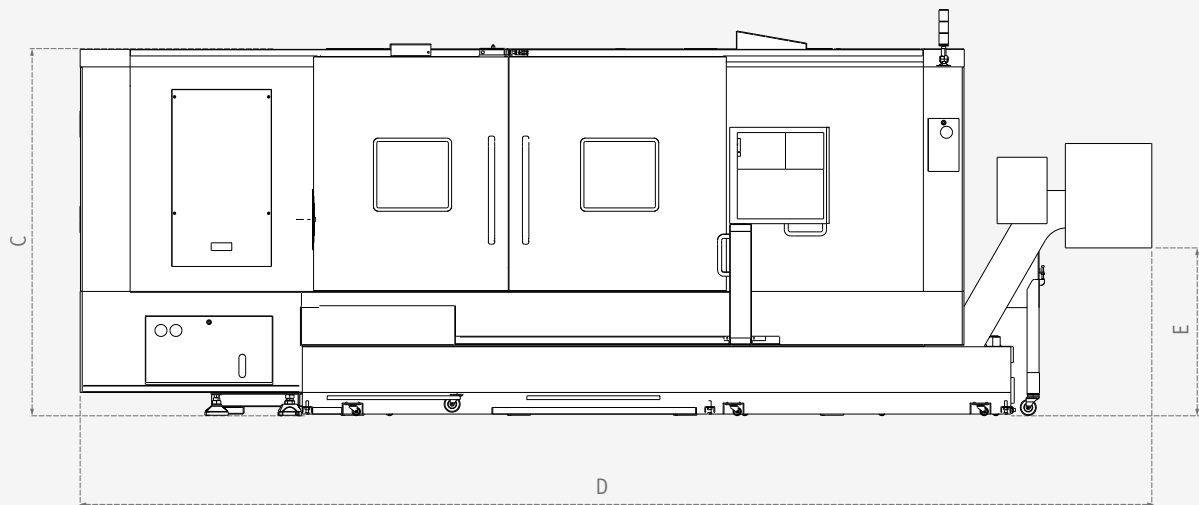

Model	A (Length)	B (Width)	C (Height)	D (Length with side chip conveyor)	E (Height of ground to chip outlet)
PUMA 3100	3908 (153.9)	1978 (77.9)	2010 [2315] (79.1 [91.1])	4819 (189.7)	1010 (39.8)
PUMA 3100L	4527 (178.2)	2067 (81.4)	2010 [2315] (79.1 [91.1])	5599 (220.4)	1010 (39.8)
PUMA 3100XL	5615 (221.1)	2280 (89.8)	2315 (91.1)	6443 (253.7)	1010 (39.8)
PUMA 3100UL	6585 (259.3)	2280 (89.8)	2315 (91.1)	7670 (302.0)	1010 (39.8)
PUMA 3100XLYB	5857 (230.6)	2280 (89.8)	2315 (91.1)	6685 (263.2)	1010 (39.8)
PUmA 3100ULYB	6827(268.8)	2280 (89.8)	2315 (91.1)	7912 (311.5)	1010 (39.8)

* Some peripheral equipment can be placed in other places

Tooling System

Basic information

Basic Structure
Cutting
Performance

Detailed Information

Options
Applications
Capacity Diagram
Specifications

Customer Support Service

PUMA 2100 / 2100L / 2600 / 2600L

Unit : mm (inch)

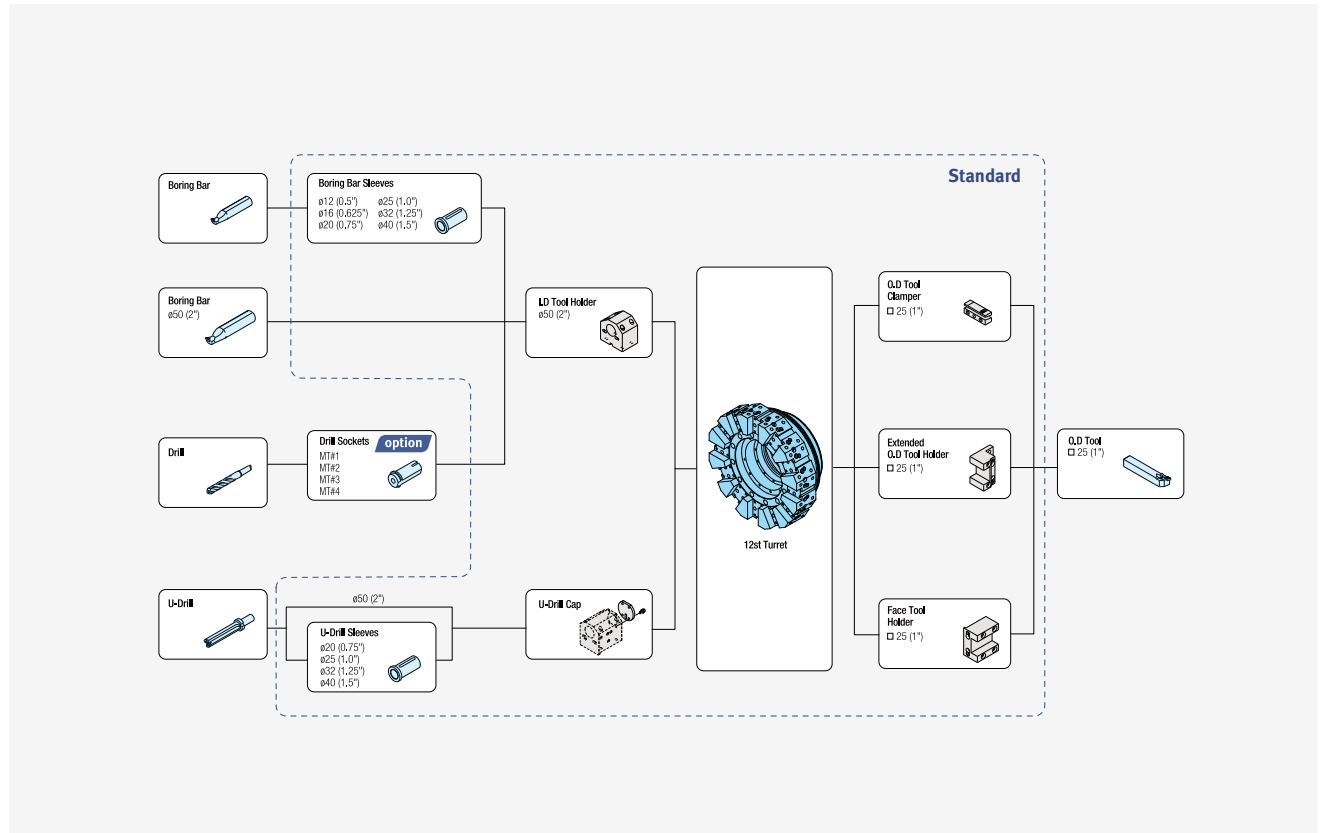

PUMA 2100S / 2100LS / 2600S / 2600LS

Unit : mm (inch)

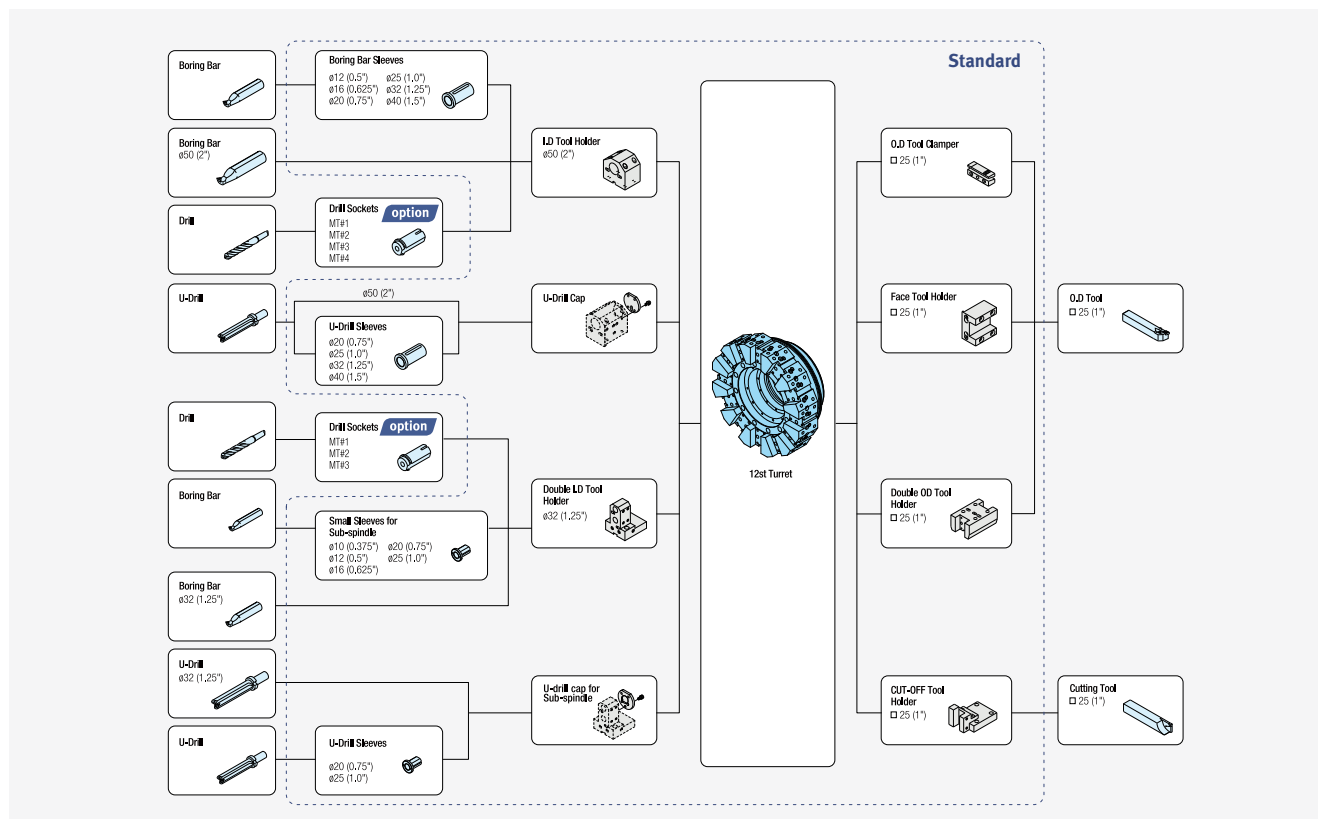

PUMA 2100M / 2100LM / 2100Y / 2100LY (12 station-BMT55P)

Unit : mm (inch)

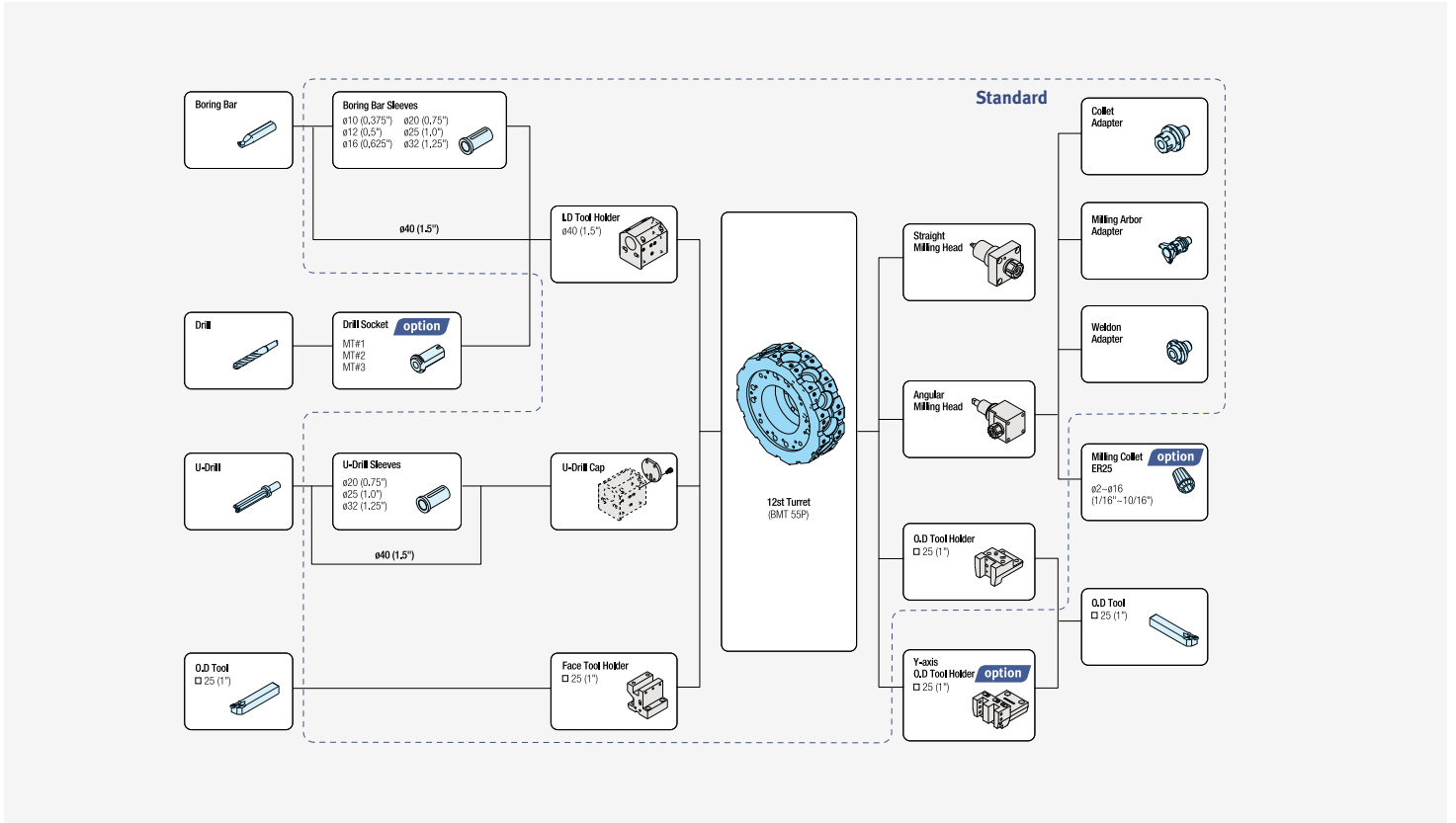

PUMA 2100M / 2100LM / 2100Y / 2100LY (24 station. - BMT55P) **option**

Unit : mm (inch)

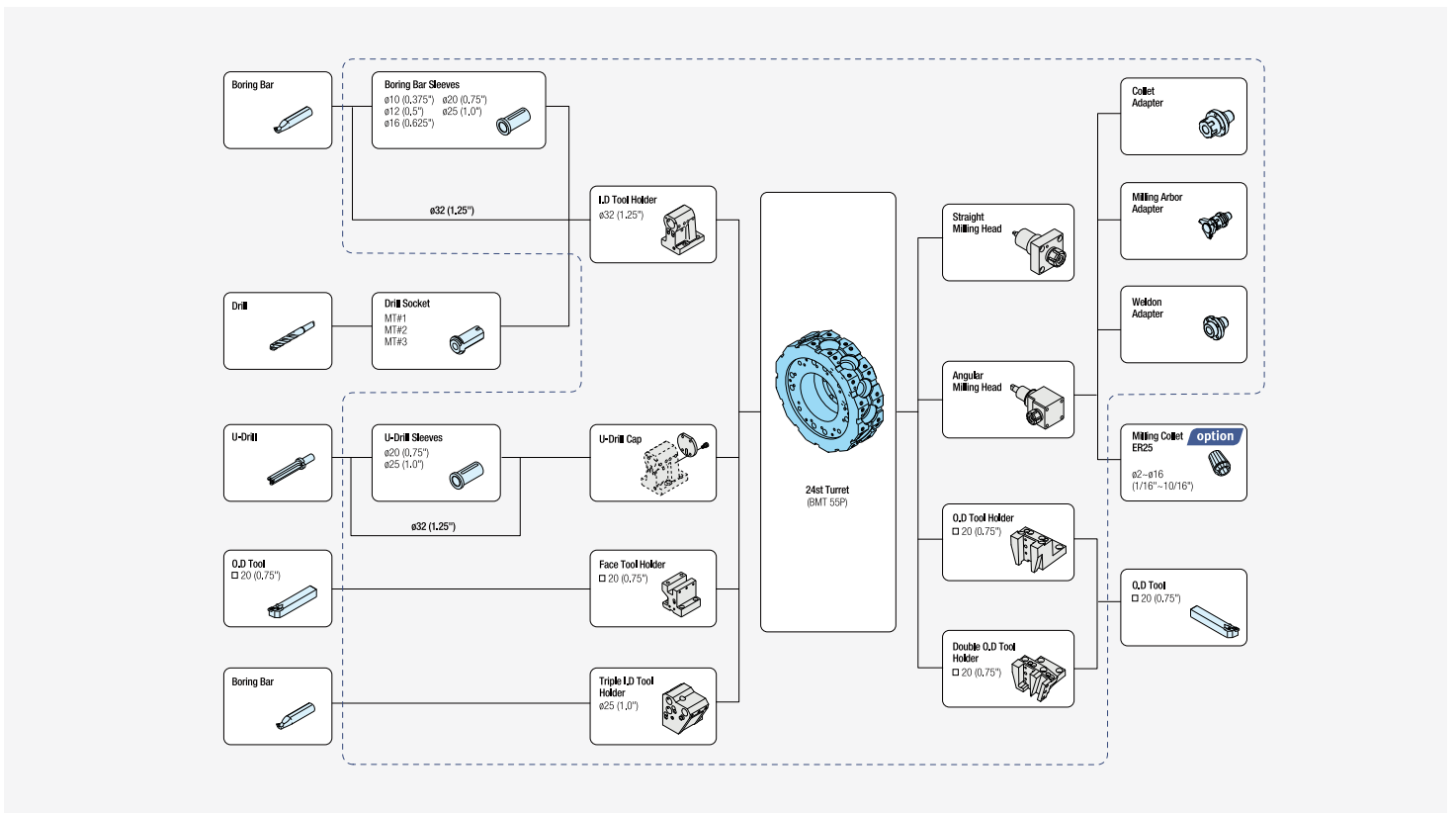

Tooling System

Basic information

Basic Structure
Cutting
Performance

Detailed Information

Options
Applications
Capacity Diagram
Specifications

Customer Support Service

PUMA 2100MS / 2100LMS / 2100SY / 2100LSY (12 station-BMT55P)

Unit : mm (inch)

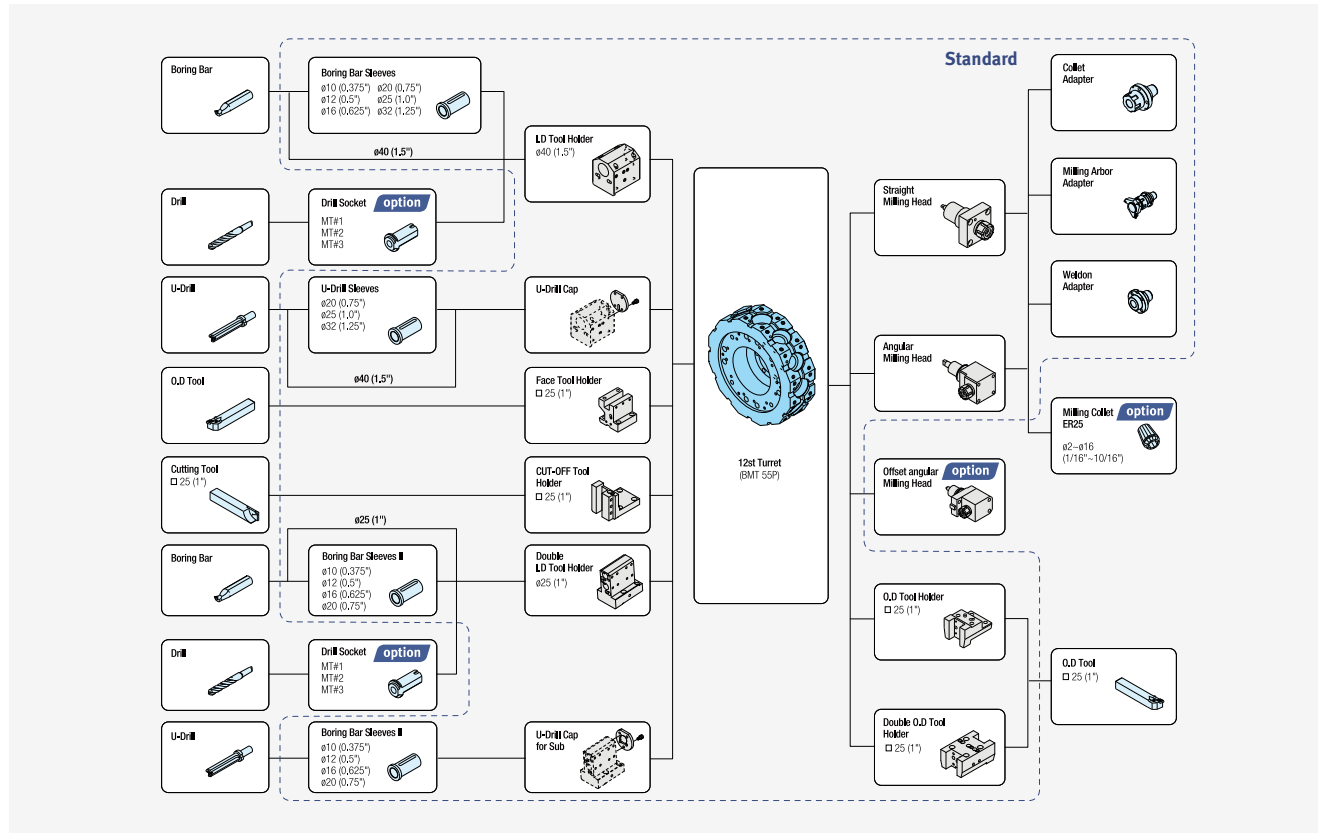

PUMA 2100MS / 2100LMS / 2100SY / 2100LSY (24 station - BMT55P) option

Unit : mm (inch)

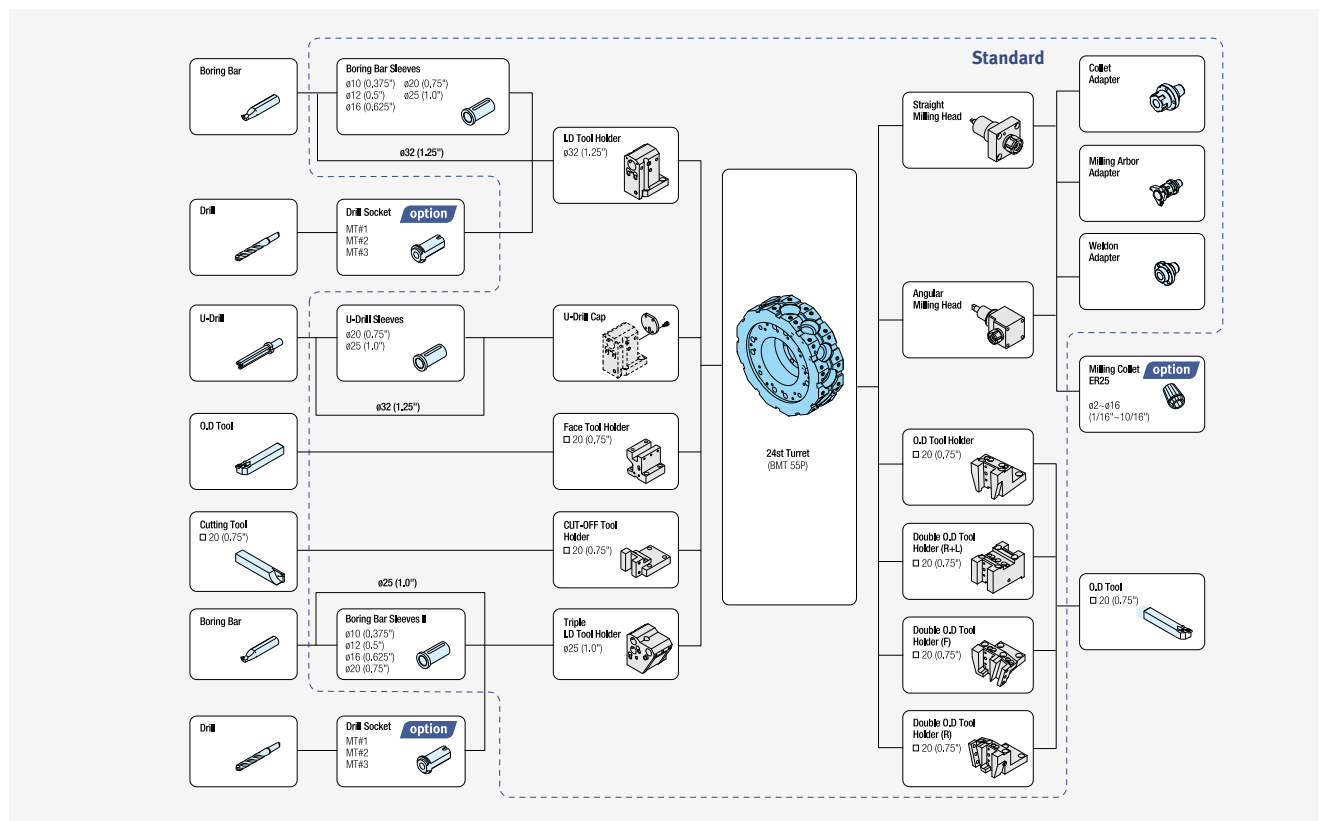

PUMA 2600M / 2600LM / 2600Y / 2600LY (12 station-BMT65P)

Unit : mm (inch)

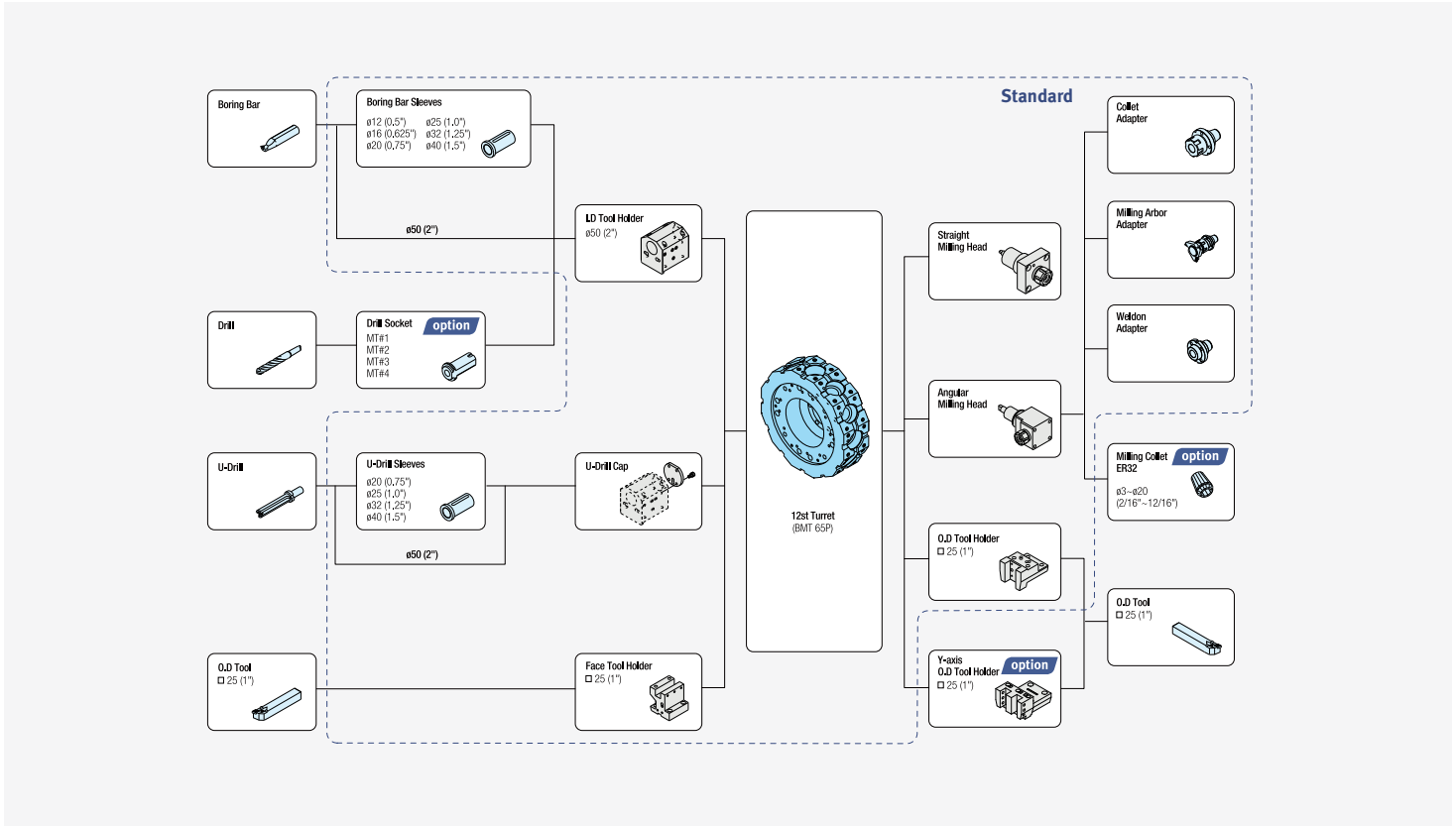

PUMA 2600M / 2600LM / 2600Y / 2600LY (24 station. - BMT65P) option

Unit : mm (inch)

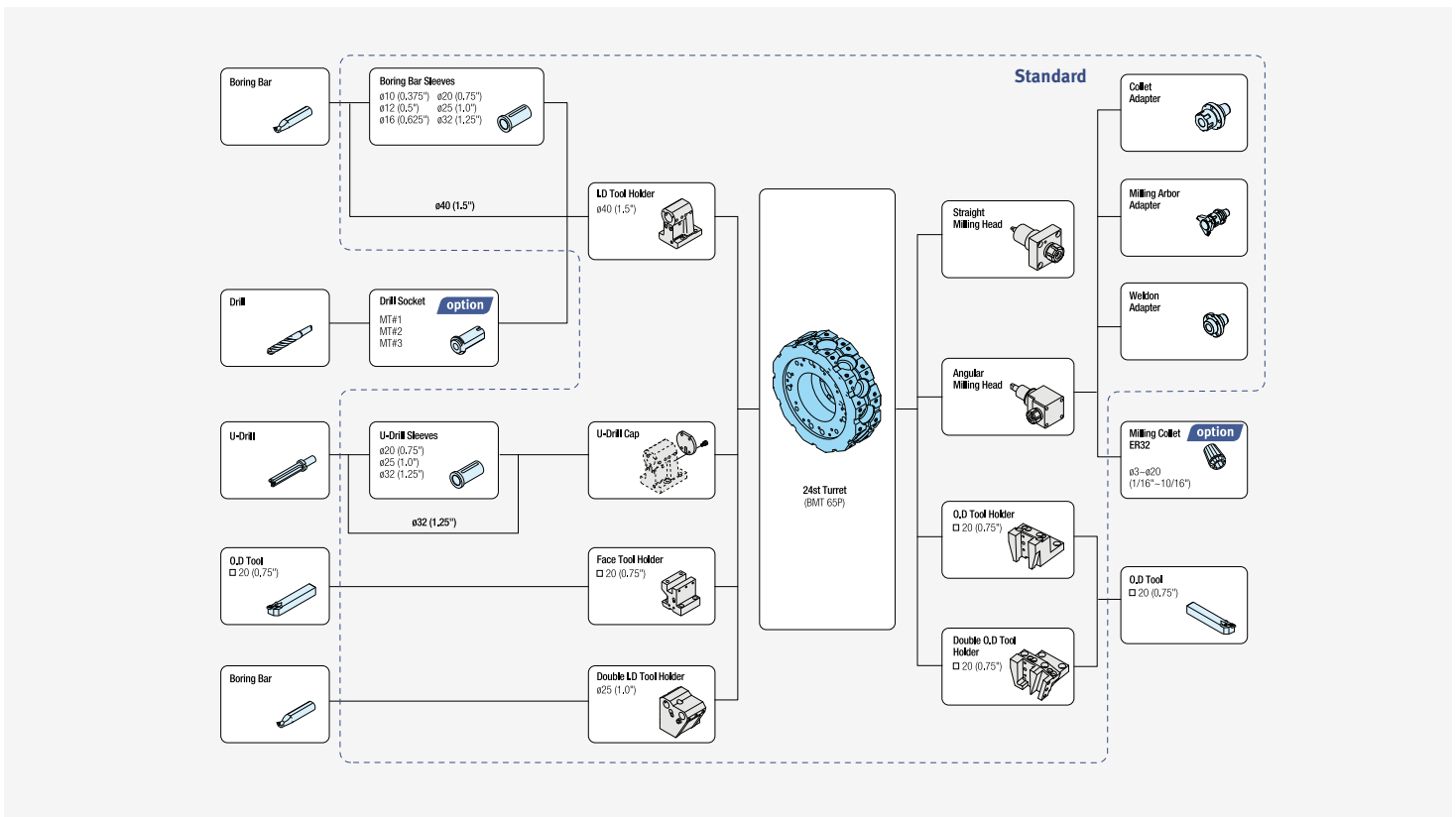

Tooling System

Basic information

- Basic Structure
- Cutting
- Performance

Detailed Information

- Options
- Applications
- Capacity Diagram
- Specifications

Customer Support Service

PUMA 2600MS / 2600LMS / 2600SY / 2600LSY (12 station-BMT65P)

Unit : mm (inch)

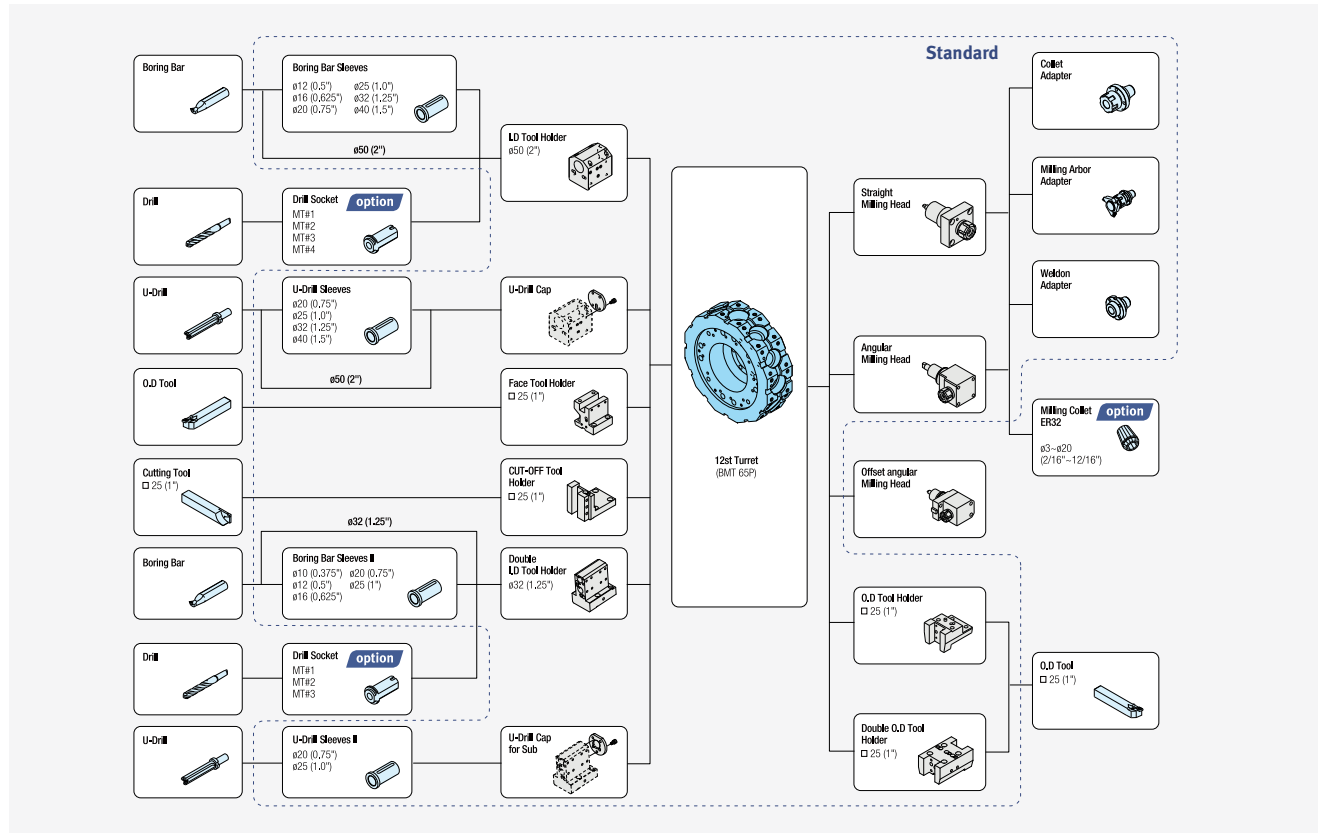

PUMA 2600MS / 2600LMS / 2600SY / 2600LSY (24 station - BMT65P) option

Unit : mm (inch)

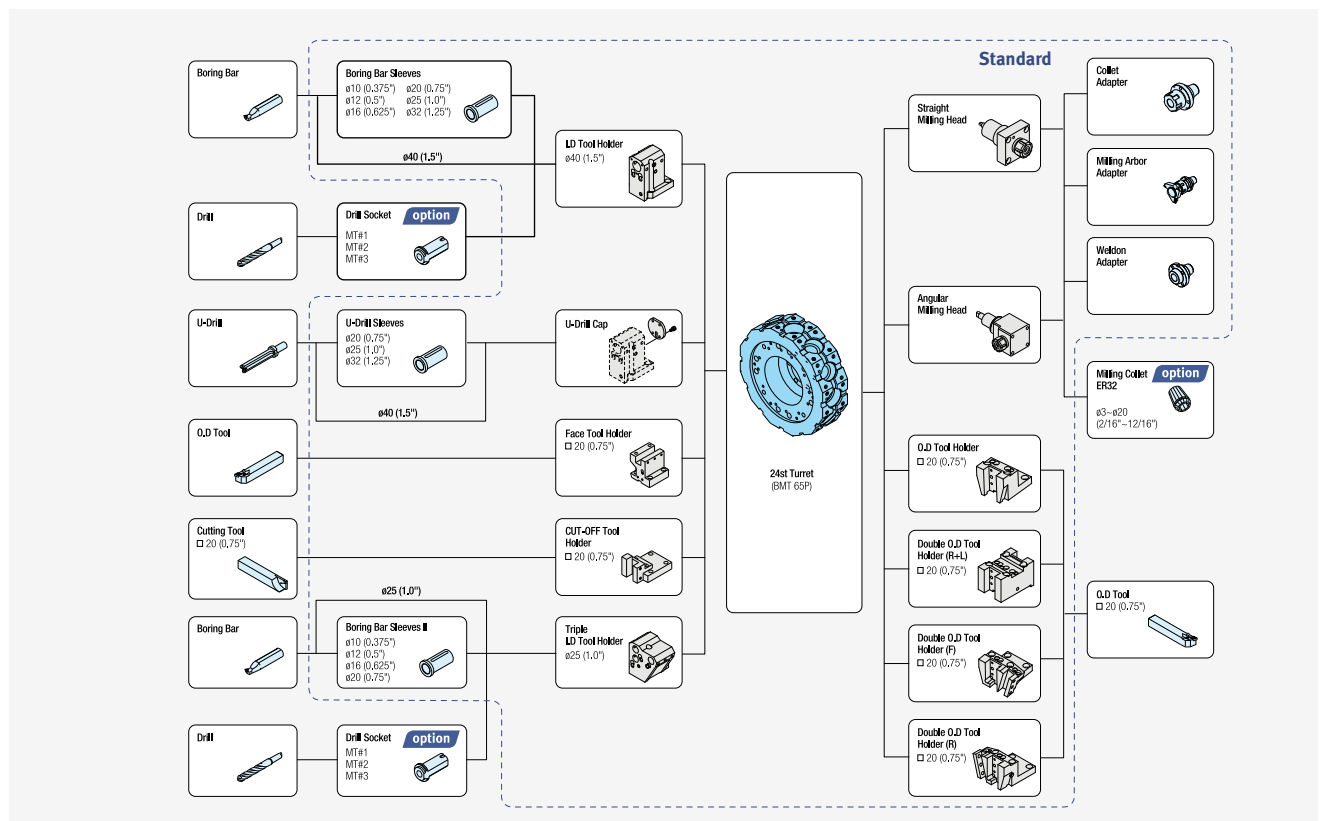

PUMA 3100 / 3100L / 3100XL / 3100UL

Unit : mm (inch)

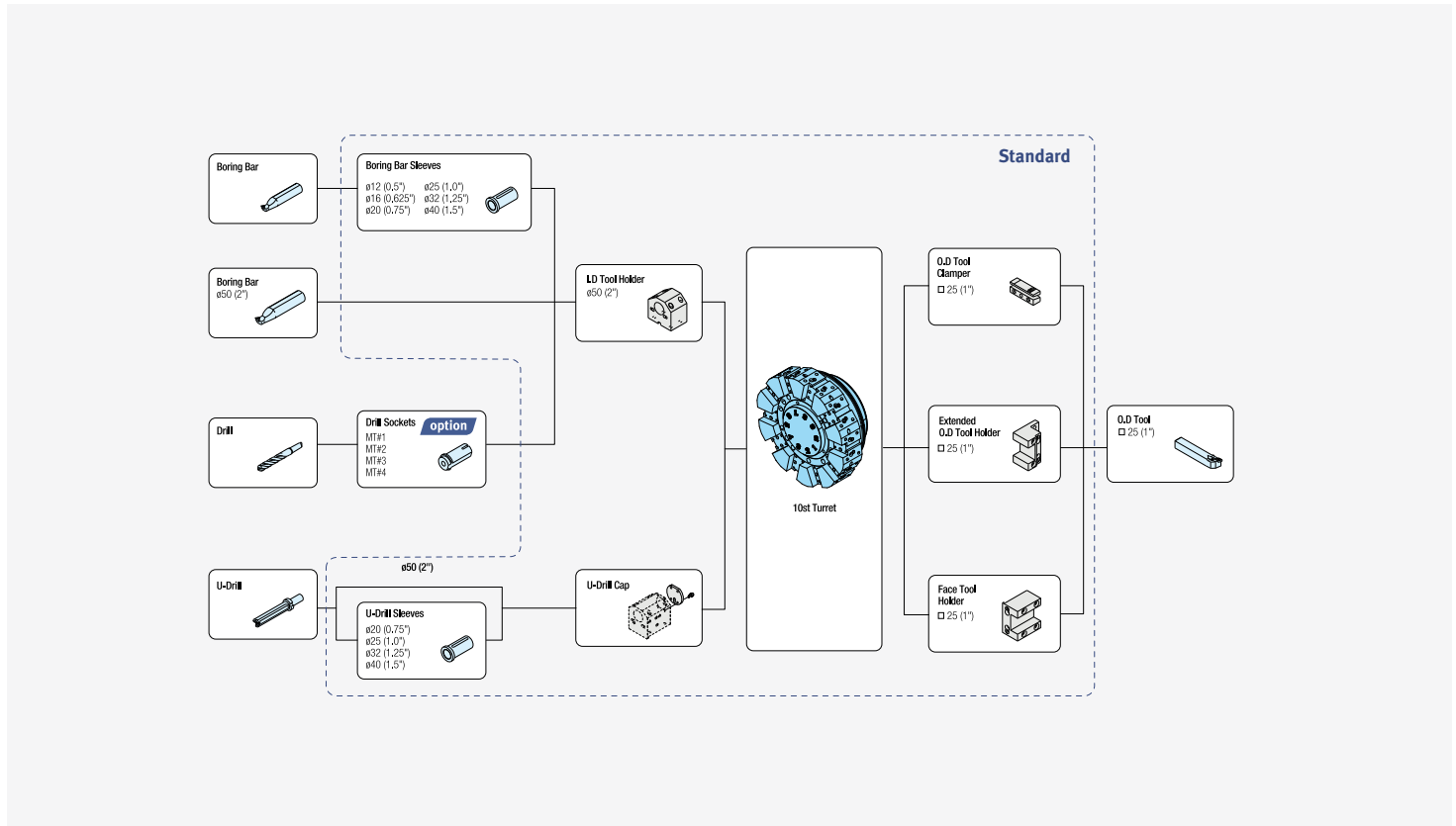

PUMA 3100M / 3100LM / 3100XLM / 3100ULM / 3100Y / 3100LY / 3100XLY / 3100ULY

Unit : mm (inch)

(12 station-BMT65P)

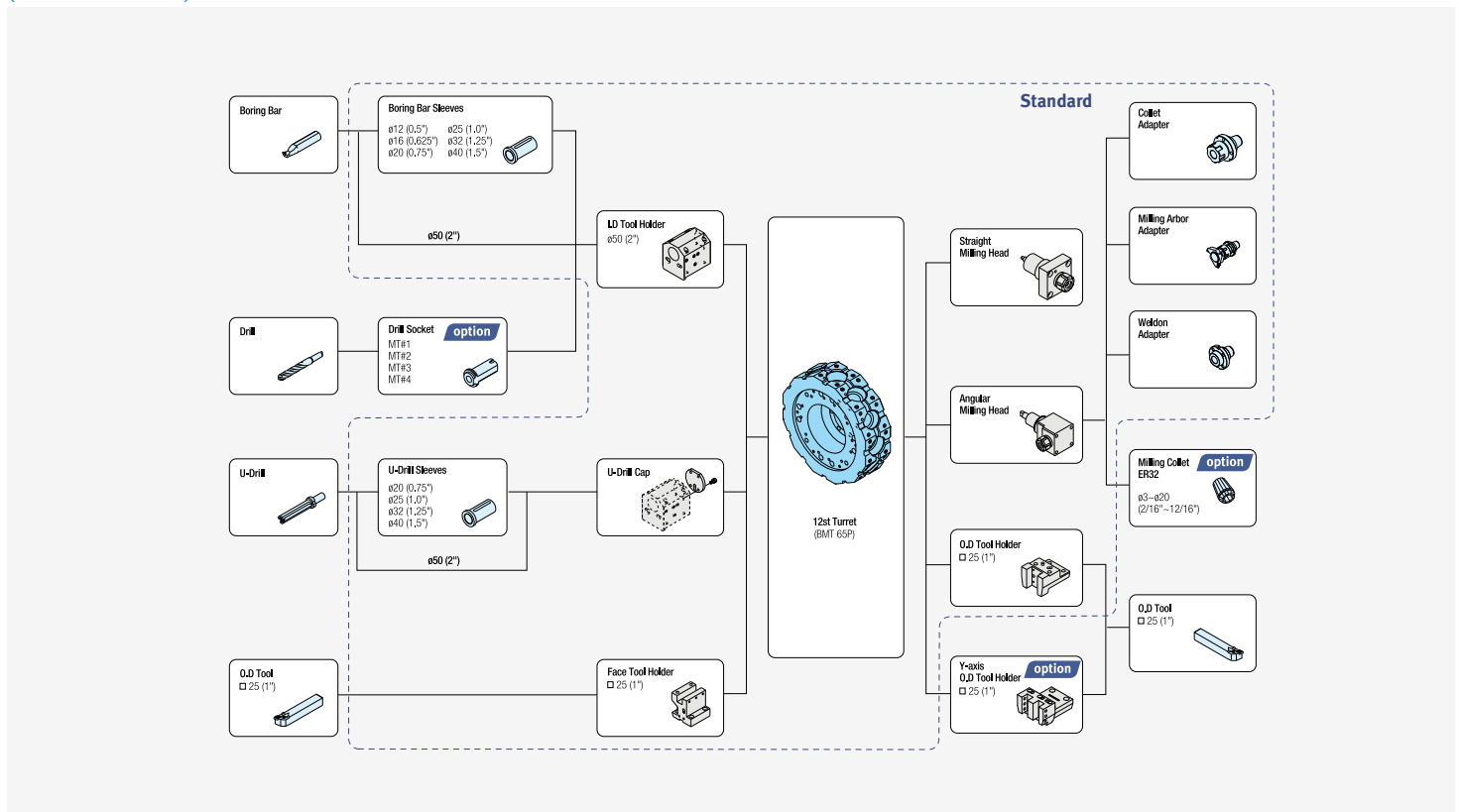

PUMA 2100M / 2100LM / 2600M / 2600LM
(12 station-BMT65P)

Unit : mm (inch)

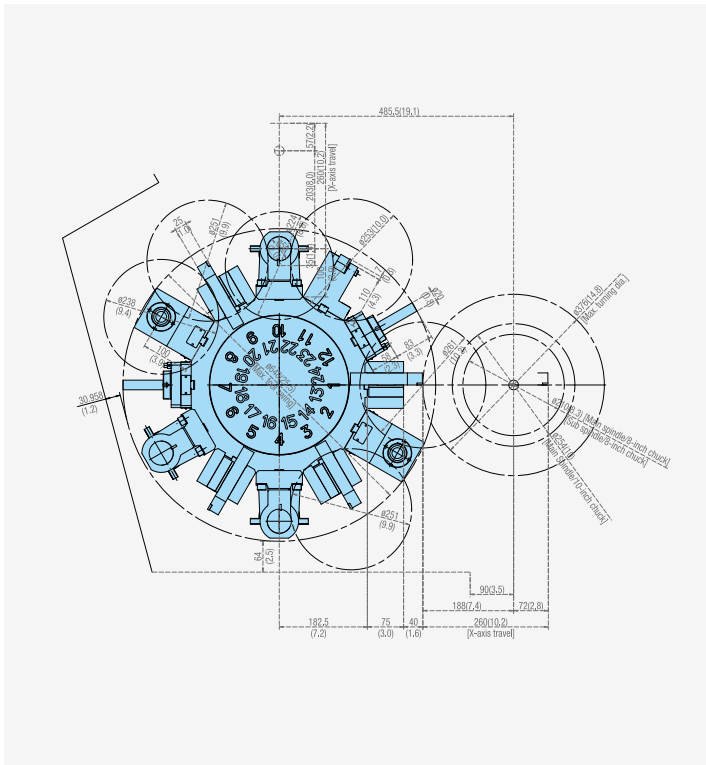

PUMA 2100MS / 2100LMS / 2600MS / 2600LMS
(12 station-BMT65P)

Unit : mm (inch)

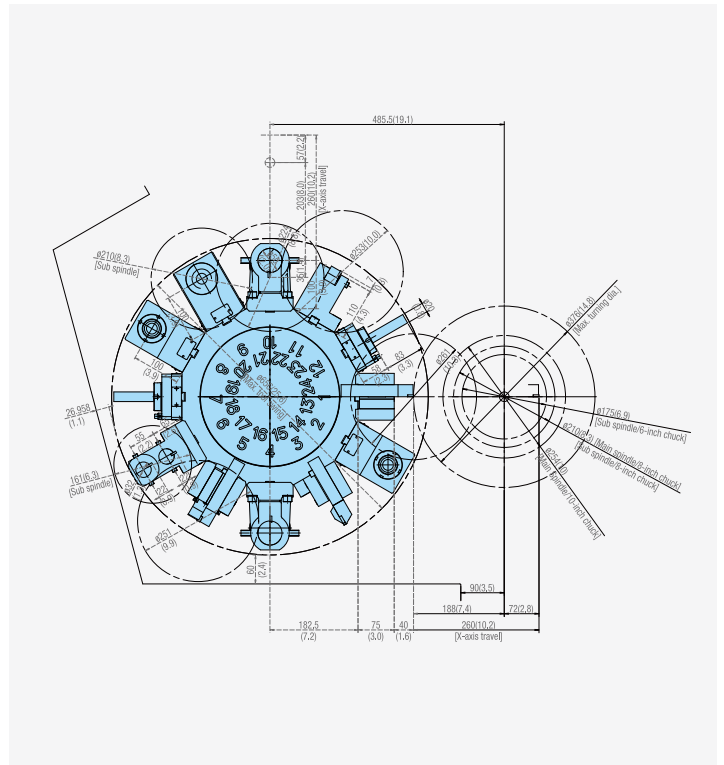

PUMA 2100M / 2100LM
(12 station- BMT55P)

Unit : mm (inch)

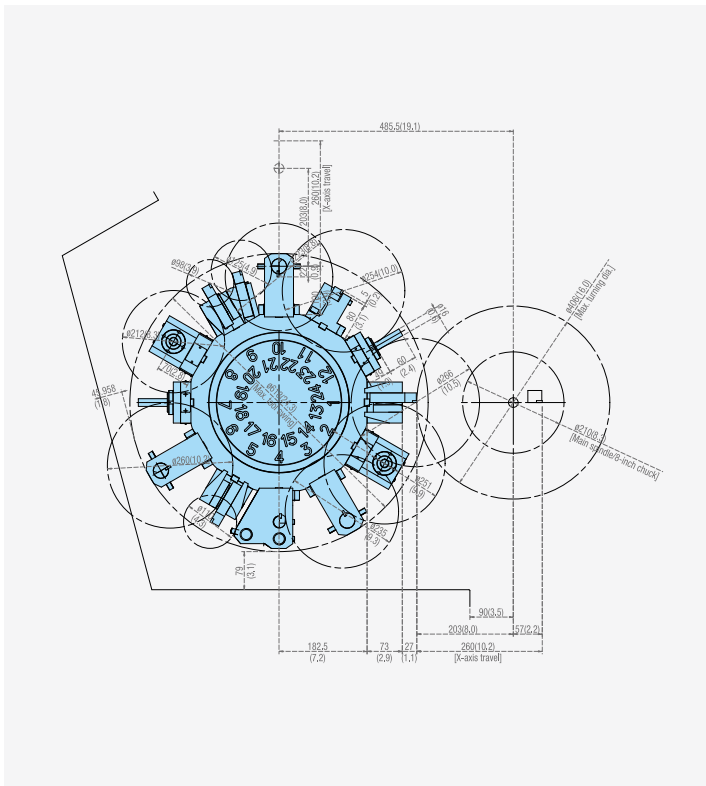

PUMA 2100MS / 2100LMS
(12 station- BMT55P)

Unit : mm (inch)

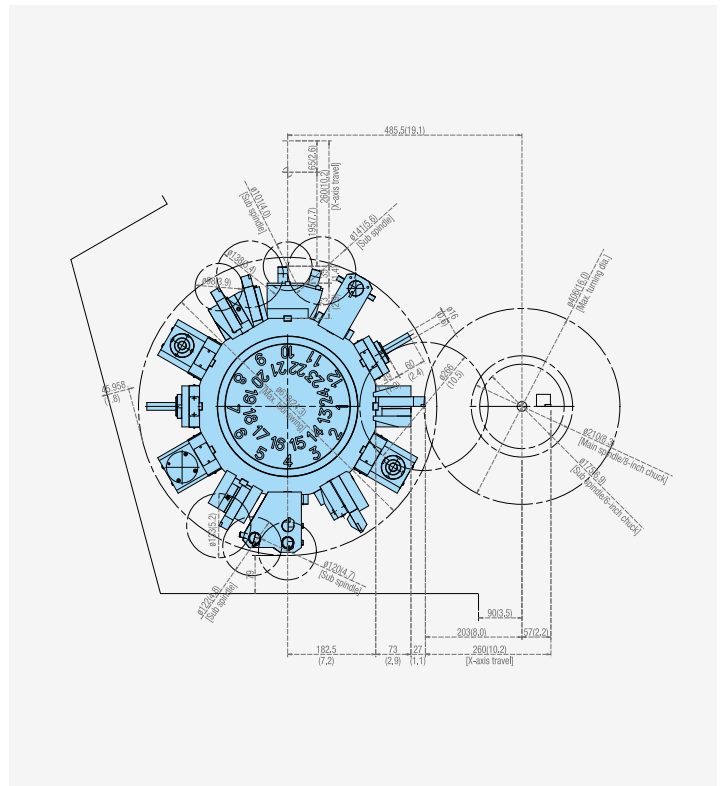

Tool Interference Diagram

Basic information

- Basic Structure
- Cutting
- Performance

Detailed Information

- Options
- Applications
- Capacity Diagram
- Specifications

Customer Support Service

PUMA 2100M / 2100LM / 2600M / 2600LM (24 station-BMT65P)

Unit : mm (inch)

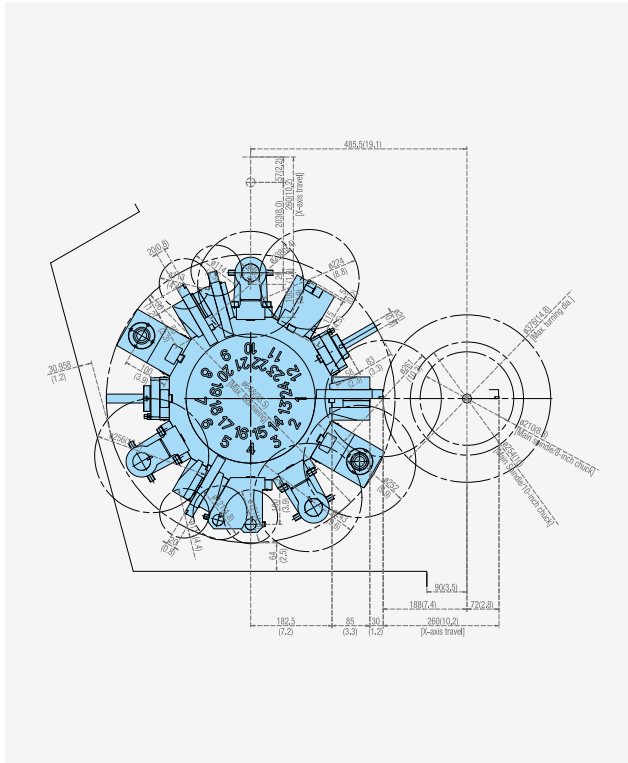

PUMA 2100MS / 2100LMS / 2600MS / 2600LMS (24 station-BMT65P)

Unit : mm (inch)

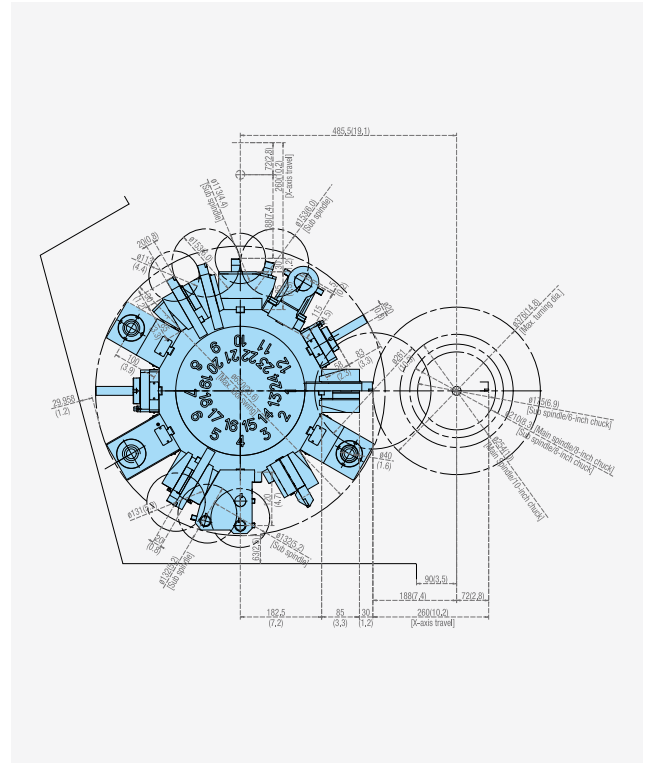

PUMA 2100SY / 2100LSY (12 station-BMT55P)

Unit : mm (inch)

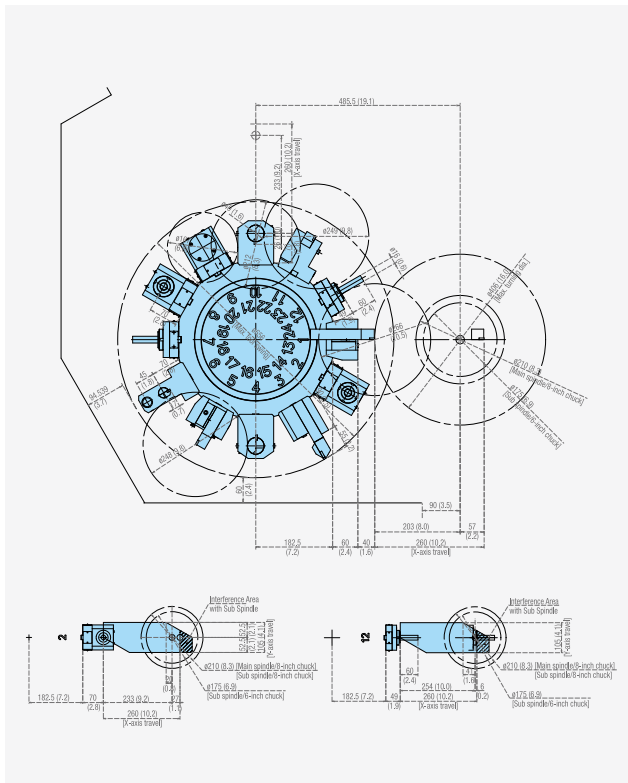

PUMA 2100Y / 2100LY (12 station-BMT55P)

Unit : mm (inch)

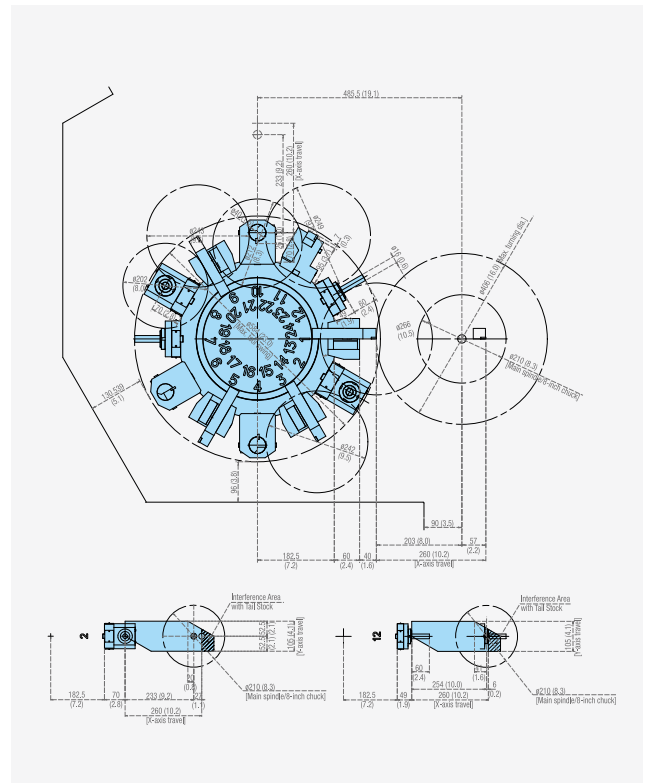

Tool Interference Diagram

Basic information

- Basic Structure
- Cutting
- Performance

Detailed Information

- Options
- Applications
- Capacity Diagram
- Specifications

Customer Support Service

PUMA 2100SY / 2100LSY / 2600SY / 2600LSY (24 station-BMT65P)

Unit : mm (inch)

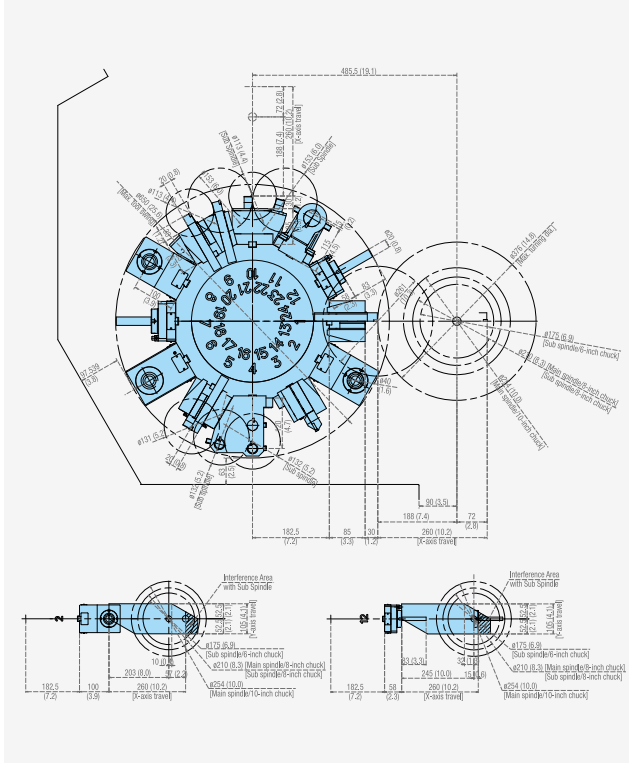

PUMA 2100Y / 2100LY / 2600Y / 2600LY (24 station-BMT65P)

Unit : mm (inch)

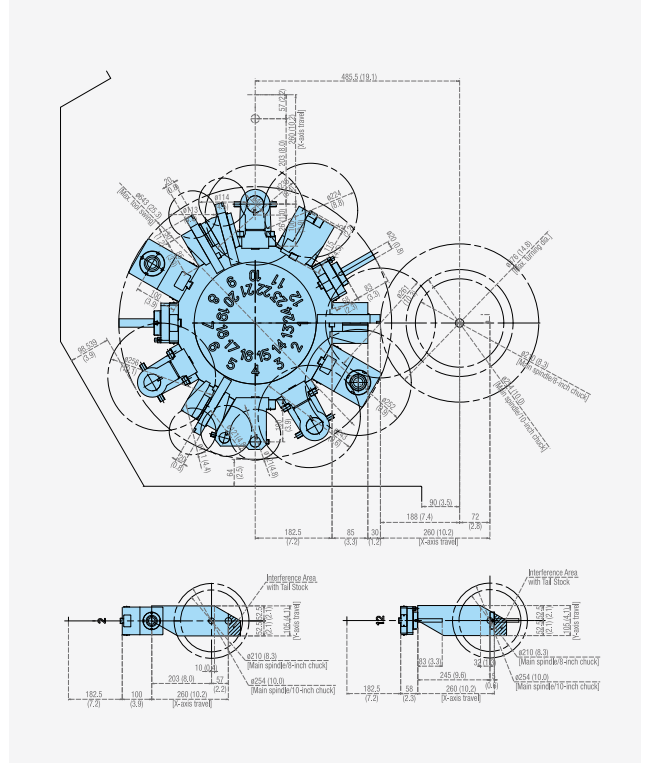

PUMA 3100 / 3100L (10 station)

Unit : mm (inch)

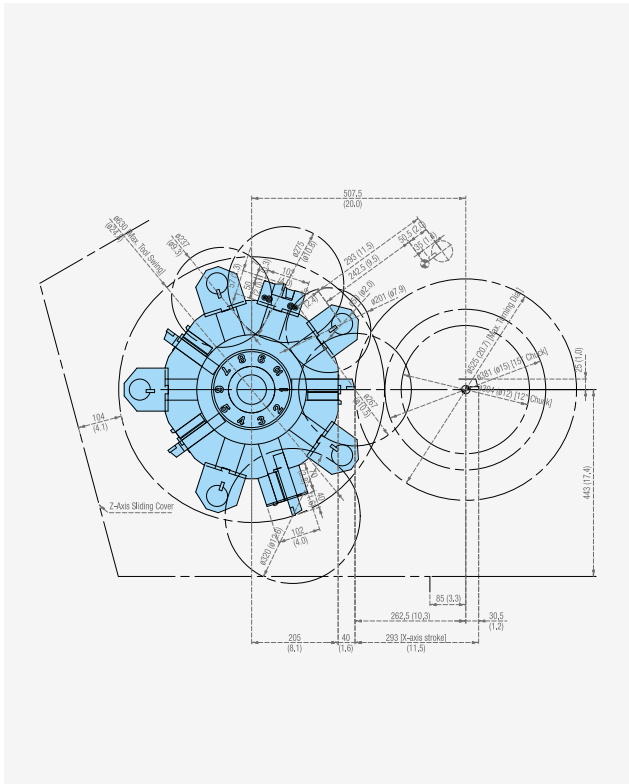

PUMA 3100XL / 3100UL (10 station)

Unit : mm (inch)

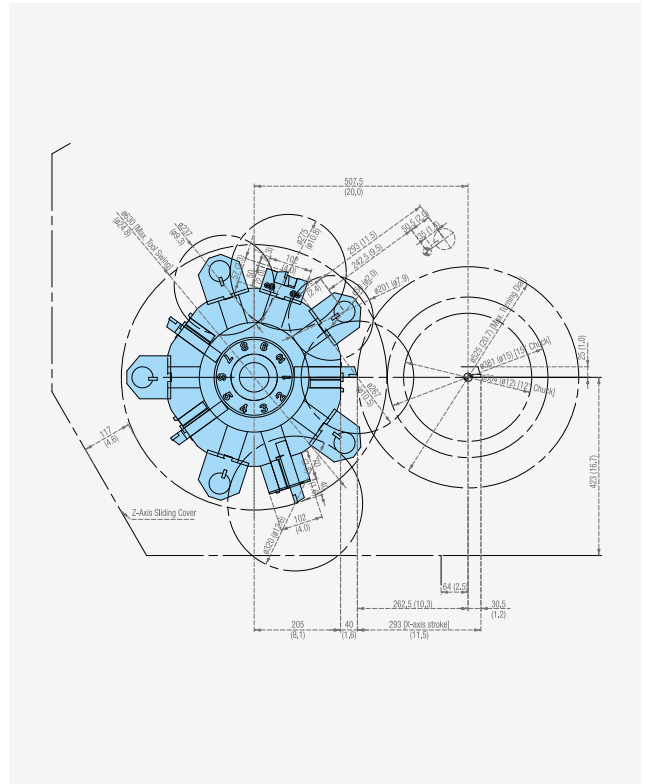

Machine Specifications

Basic information

Basic Structure
Cutting
Performance

Detailed Information

Options
Applications
Capacity Diagram
Specifications

Customer Support Service

PUMA 2100 series

Description		Unit	PUMA 2100/L	PUMA 2100M/LM	PUMA 2100MS/LMS
Capacity	Swing over bed	mm (inch)	780 (30.7)		
	Swing over front door	mm (inch)	680 (26.8)		
	Swing over saddle*	mm (inch)	630 (24.8)		
	Recom. Turning diameter	mm (inch)	210 (8.3)		
	Max. turning diameter	mm (inch)	481 (18.9)	406 (16.0)	
	Max. turning length	mm (inch)	545 / 785 (21.5 / 30.9)	520 / 760 (20.5 / 29.9)	
	Bar working diameter	mm (inch)	65 (2.6)		
Travels	Travel distance	X-axis	mm (inch)	260 (10.2)	
		Z-axis	mm (inch)	590 / 830 (23.2 / 32.7)	
		Y-axis	mm (inch)	-	
		B-axis	mm (inch)	-	590 / 830 (23.2 / 32.7)
Feedrates	Rapid traverse	X-axis	m/min (ipm)	30 (1181.1)	
		Z-axis	m/min (ipm)	30 (1181.1)	
		Y-axis	m/min (ipm)	-	
		B-axis	m/min (ipm)	-	30 (1181.1)
Spindle	Spindle speed (Belt Type)	r/min	4500		
	Spindle speed (Built-in Type)	r/min	-		
	Spindle nose		ASA A2#6		
	Spindle bearing diameter (Front)	mm (inch)	120 (4.7)		
	Spindle through hole diameter	mm (inch)	76 (3.0)		
	Min. spindle indexing angle (C-axis)	deg	-	0.001	
Turret	No. of tool stations	st	12	12 {24}*	
	OD tool size	mm (inch)	25 (1.0)	25 {20}* (1.0 {0.8})	
	Boring bar diameter	mm (inch)	50 (2.0)	40 {32}* (1.6 {1.3})	
	Indexing time (1st swivel time)	s	0.15		
	Rotary tool spindle speed	r/min	-	5000	
Tail stock	Quill diameter	mm (inch)	80 (3.1)	-	
	Quill bore taper (Live)		MT#4		
	Compressed air supply	mm (inch)	80 (3.1)	-	
Sub-spindle	Spindle speed (Belt [Built-in])	r/min	-	4500	
	Spindle nose		-	ASA A2-5	
	Spindle bearing diameter (Front)	mm (inch)	-	90 (3.5)	
	Spindle through hole diameter	mm (inch)	-	62 (2.4)	
	Min. spindle indexing angle (C-axis)	deg	-	0.001	
Motors	Main spindle motor	kW (Hp)	18.5 / 15 (25 / 20)		
	Sub spindle motor	kW (Hp)	-	7.5 / 5.5 (10 / 7)	
	Rotary tool spindle motor	kW (Hp)	-	5.5 (7)	
	Coolant pump motor	kW (Hp)	0.4 (0)		
Power source	Electric power supply (Rated capacity)	kVA	35.63	38.41	45.63
Machine size	Machine height	mm (inch)	1900 (74.8)		
	Machine dimension	length	mm (inch)	3310 / 3530 (130.3 / 139.0)	
		width	mm (inch)	1863 (73.3)	
	Machine weight	kg (lb)	4850 / 5350 (10692.3 / 11794.6)	5000 / 5500 (11023.0 / 12125.2)	5450 / 5950 (12015.0 / 13117.3)

*{ } : Option

* The specifications and information above-ntioned may be changed without prior notice.

* For more details, please contact Doosan.

Machine Specifications

PUMA 2100 / 2600 series

Description		Unit	PUMA 2100Y/LY	PUMA 2100SY/LSY	PUMA 2600/L	PUMA 2600M/LM	
Capacity	Swing over bed	mm (inch)	780 (30.7)				
	Swing over front door	mm (inch)	680 (26.8)				
	Swing over saddle*	mm (inch)	630 (24.8)				
	Recom. Turning diameter	mm (inch)	210 (8.3)		255 (10.0)		
	Max. turning diameter	mm (inch)	406 (16.0)		481 (18.9)	376 (14.8)	
	Max. turning length	mm (inch)	520 / 760 (20.5 / 29.9)		790 / 1310 (31.1 / 51.6)	760 / 1280 (29.9 / 50.4)	
	Bar working diameter	mm (inch)	65 (2.6)		76 (3.0)		
Travels	Travel distance	X-axis	mm (inch)	260 (10.2)			
		Z-axis	mm (inch)	590 / 830 (23.2 / 32.7)		830 / 1350 (32.7 / 53.1)	
		Y-axis	mm (inch)	105 (4.1)		-	
		B-axis	mm (inch)	-	590 / 830 (23.2 / 32.7)	-	
Feedrates	Rapid traverse	X-axis	m/min (ipm)	30 (1181.1)			
		Z-axis	m/min (ipm)	30 (1181.1)			
		Y-axis	m/min (ipm)	10 (393.7)		-	
		B-axis	m/min (ipm)	-	30 (1181.1)	-	
Spindle	Spindle speed (Belt Type)	r/min	4500		3500		
	Spindle speed (Built-in Type)	r/min	PUMA 2100Y II series		-		
	Spindle nose		ASA A2#6		ASA A2#8		
	Spindle bearing diameter (Front)	mm (inch)	120 (4.7)		140 (5.5)		
	Spindle through hole diameter	mm (inch)	76 (3.0)		86 (3.4)		
	Min. spindle indexing angle (C-axis)	deg	0.001		-	0.001	
Turret	No. of tool stations	st	12 {24} {16}*		12	12 {24}*	
	OD tool size	mm (inch)	25 {20} {25} (1.0 {0.8} {1.0})*		25 (1.0)	25 {20} (1.0 {0.8})*	
	Boring bar diameter	mm (inch)	40 {32} {32} (1.6 {1.3} {1.3})*		50 (2.0)	50 {40} (2.0 {1.6})*	
	Indexing time (1st swivel time)	s	0.15				
	Rotary tool spindle speed	r/min	5000		-	5000	
Tail stock	Quill diameter	mm (inch)	80 (3.1)	-	100 (3.9)		
	Quill bore taper (Live)		MT#4	-	MT#5		
	Compressed air supply	mm (inch)	80 (3.1)	-	100 (3.9)		
Sub-spindle	Spindle speed (Belt [Built-in])	r/min	-	4500 [PUMA 2100SY II /LSY II]		-	
	Spindle nose		-	ASA A2-5		-	
	Spindle bearing diameter (Front)	mm (inch)	-	90		-	
	Spindle through hole diameter	mm (inch)	-	62		-	
	Min. spindle indexing angle (C-axis)	deg	-	0.001		-	
Motors	Main spindle motor	kW (Hp)	18.5 / 15 (25 / 20)		22 / 18.5 (30 / 25)		
	Sub spindle motor	kW (Hp)	-	7.5 / 5.5 (10 / 7)		-	
	Rotary tool spindle motor	kW (Hp)	5.5 (7)		-		
	Coolant pump motor	kW (Hp)	0.4 (0)				
Power source	Electric power supply (Rated capacity)	kVA	41.32	48.54	40.72	43.5	
Machine size	Machine height	mm (inch)	2163 (85.2)		1900 (74.8)		
	Machine dimension	length	mm (inch)	3310 / 3530 (130.3 / 139.0)		3600 / 4335 (141.7 / 170.7)	
		width	mm (inch)	1863 (73.3)		1863 / 1965 (73.3 / 77.4)	
	Machine weight	kg (lb)	5450 / 5950 (12015.0 / 13117.3)	5900 / 6400 (13007.1 / 14109.4)	5400 / 6700 (11904.8 / 14770.8)	5550 / 6850 (12235.5 / 15101.4)	

*{ } : Option

* The specifications and information above-ntioned may be changed without prior notice.

* For more details, please contact Doosan.

Basic information

Basic Structure
Cutting
Performance

Detailed Information

Options
Applications
Capacity Diagram
Specifications

Customer Support Service

PUMA 2600 series

Description		Unit	PUMA 2600MS/LMS	PUMA 2600Y/LY	PUMA 2600SY/LSY	
Capacity	Swing over bed	mm (inch)	780 (30.7)			
	Swing over front door	mm (inch)	680 (26.8)			
	Swing over saddle*	mm (inch)	630 (24.8)			
	Recom. Turning diameter	mm (inch)	255 (10.0)			
	Max. turning diameter	mm (inch)	376 (14.8)	376 (14.8)		
	Max. turning length	mm (inch)	760 / 1280 (29.9 / 50.4)	760 / 1280 (29.9 / 50.4)		
	Bar working diameter	mm (inch)	76 (3.0)			
Travels	Travel distance	X-axis	mm (inch)	260 (10.2)		
		Z-axis	mm (inch)	830 / 1350 (32.7 / 53.1)		
		Y-axis	mm (inch)	-	105 (±52.5) (4.1 (±2.1))	
		B-axis	mm (inch)	830 / 1350 (32.7 / 53.1)	-	830 / 1350 (32.7 / 53.1)
Feedrates	Rapid traverse	X-axis	m/min (ipm)	30 (1181.1)		
		Z-axis	m/min (ipm)	30 (1181.1)		
		Y-axis	m/min (ipm)	-	10 (393.7)	
		B-axis	m/min (ipm)	30 (1181.1)	-	30 (1181.1)
Spindle	Spindle speed (Belt Type)	r/min	3500			
	Spindle speed (Built-in Type)	r/min	-	PUMA 2600Y II series		
	Spindle nose		ASA A2#8			
	Spindle bearing diameter (Front)	mm (inch)	140 (5.5)			
	Spindle through hole diameter	mm (inch)	86 (3.4)			
	Min. spindle indexing angle (C-axis)	deg	0.001	0.001		
Turret	No. of tool stations	st	12 {24}*	12 {24}*		
	OD tool size	mm (inch)	25 {20}* (1.0 {0.8})	25 {20}* (1.0 {0.8})		
	Boring bar diameter	mm (inch)	50 {40}* (2.0 {1.6})	50 {40}* (2.0 {1.6})		
	Indexing time (1st swivel time)	s	0.15			
	Rotary tool spindle speed	r/min	5000	5000		
Tail stock	Quill diameter	mm (inch)	-	100 (3.9)	-	
	Quill bore taper (Live)		-	MT#5	-	
	Compressed air supply	mm (inch)	-	100 (3.9)	-	
Sub-spindle	Spindle speed (Belt [Built-in])	r/min	4500	-	4500 [PUMA 2600SY II /LSY II]	
	Spindle nose		ASA A2-5	-	ASA A2-5	
	Spindle bearing diameter (Front)	mm (inch)	90 (3.5)	-	90 (3.5)	
	Spindle through hole diameter	mm (inch)	62 (2.4)	-	62 (2.4)	
	Min. spindle indexing angle (C-axis)	deg	0.001	-	0.001	
Motors	Main spindle motor	kW (Hp)	22 / 18.5 (30 / 25)			
	Sub spindle motor	kW (Hp)	7.5 / 5.5 (11 / 7)	-	7.5 / 5.5 (11 / 7)	
	Rotary tool spindle motor	kW (Hp)	5.5 {7.5}* (7 {10})	5.5 {7.5}* (7 {10})		
	Coolant pump motor	kW (Hp)	0.4 (0.5)			
Power source	Electric power supply (Rated capacity)	kVA	51.65	46.4	54.55	
Machine size	Machine height	mm (inch)	1900 (74.8)	2163 (85.2)		
	Machine dimension	length	mm (inch)	3600 / 4335 (141.7 / 170.7)	3600 / 4435 (141.7 / 174.6)	
		width	mm (inch)	1863 / 1965 (73.3 / 77.4)		
	Machine weight	kg (lb)	6000 / 7300 (13227.5 / 16093.5)	6000 / 7300 (13227.5 / 16093.5)	6450 / 7750 (14219.6 / 17085.6)	

* { } : Option

* The specifications and information above-ntioned may be changed without prior notice.

* For more details, please contact Doosan.

Machine Specifications

PUMA 2600 series

Description		Unit	PUMA 2600/500	PUMA 2600M/500	PUMA 2600B/LB	PUMA 2600MB/LMB	
Capacity	Swing over bed	mm (inch)	780 (30.7)				
	Swing over front door	mm (inch)	680 (26.8)				
	Swing over saddle*	mm (inch)	630 (24.8)				
	Recom. Turning diameter	mm (inch)	255 (10.0)		305 (12.0)		
	Max. turning diameter	mm (inch)	481 (18.9)	376 (14.8)	481 (18.9)	376 (14.8)	
	Max. turning length	mm (inch)	550 (21.7)	520 (20.5)	755 / 1275 (29.7 / 50.2)	725 / 1245 (28.5 / 49.0)	
	Bar working diameter	mm (inch)	65 (2.6)		102 (4.0)		
Travels	Travel distance	X-axis	mm (inch)	260 (10.2)			
		Z-axis	mm (inch)	590 (23.2)	830 / 1350 (32.7 / 53.1)		
		Y-axis	mm (inch)	-			
		B-axis	mm (inch)	-			
Feedrates	Rapid traverse	X-axis	m/min (ipm)	30 (1181.1)			
		Z-axis	m/min (ipm)	30 (1181.1)			
		Y-axis	m/min (ipm)	-			
		B-axis	m/min (ipm)	-			
Spindle	Spindle speed (Belt Type)	r/min	3500		2800		
	Spindle nose		ASA A2-8		A2-11		
	Spindle bearing diameter (Front)	mm (inch)	140 (5.5)		160 (6.3)		
	Spindle through hole diameter	mm (inch)	86 (3.4)		115 (4.5)		
	Min. spindle indexing angle (C-axis)	deg	0.001				
Turret	No. of tool stations	st	12	12 {24}*	12	12 {24}*	
	OD tool size	mm (inch)	25 (1.0)	25 {20}* (1.0 {0.8})	25	25 {20}* (1.0 {0.8})	
	Boring bar diameter	mm (inch)	50 (2.0)	50 {40}* (2.0 {1.6})	50	50 {40}* (2.0 {1.6})	
	Indexing time (1st swivel time)	s	0.15				
	Rotary tool spindle speed	r/min	-	5000	-	5000	
Tail stock	Quill diameter	mm (inch)	100 (3.9)				
	Quill bore taper (Live)		MT#5				
	Compressed air supply	mm (inch)	100 (3.9)				
Sub-spindle	Spindle speed (Belt [Built-in])	r/min	-				
	Spindle nose		-				
	Spindle bearing diameter (Front)	mm (inch)	-				
	Spindle through hole diameter	mm (inch)	-				
	Min. spindle indexing angle (C-axis)	deg	-				
Motors	Main spindle motor	kW (Hp)	18.5 / 15 (25 / 20)		22 / 18.5 (30 / 25)		
	Sub spindle motor	kW (Hp)	-				
	Rotary tool spindle motor	kW (Hp)	-	5.5 (7)	-	5.5 (7)	
	Coolant pump motor	kW (Hp)	0.4 (0)				
Power source	Electric power supply (Rated capacity)	kVA	40.72	44.42	40.72	44.42	
Machine size	Machine height	mm (inch)	1900 (74.8)				
	Machine dimension	length	mm (inch)	3370 (132.7)		3700 {4438}* (145.7 {174.7})	
		width	mm (inch)	1863 (73.3)			
	Machine weight	kg (lb)	4900 (10802.5)	5000 (11023.0)	5500 / 6800 (12125.2 / 14991.2)	5650 / 6950 (12455.9 / 15321.9)	

* { } : Option

* The specifications and information above-ntioned may be changed without prior notice.

* For more details, please contact Doosan.

Machine Specifications

Basic information

Basic Structure
Cutting
Performance

Detailed Information

Options
Applications
Capacity Diagram
Specifications

Customer Support Service

PUMA 2600 series

Description		Unit	PUMA 2600SB	PUMA 2600MSB	
Capacity	Swing over bed	mm (inch)	780 (30.7)		
	Swing over front door	mm (inch)	680 (26.8)		
	Swing over saddle*	mm (inch)	630 (24.8)		
	Recom. Turning diameter	mm (inch)	305 (12.0)		
	Max. turning diameter	mm (inch)	481 (18.9)	376 (14.8)	
	Max. turning length	mm (inch)	755 (29.7)	725 (28.5)	
	Bar working diameter	mm (inch)	102 (4.0)		
Travels	Travel distance	X-axis	mm (inch)	260 (10.2)	
		Z-axis	mm (inch)	830 (32.7)	
		Y-axis	mm (inch)	-	
		B-axis	mm (inch)	830 (32.7)	
Feedrates	Rapid traverse	X-axis	m/min (ipm)	30 (1181.1)	
		Z-axis	m/min (ipm)	30 (1181.1)	
		Y-axis	m/min (ipm)	-	
		B-axis	m/min (ipm)	30 (1181.1)	
Spindle	Spindle speed (Belt Type)		r/min	2800	
	Spindle nose			ASA A2-11	
	Spindle bearing diameter (Front)		mm (inch)	160 (6.3)	
	Spindle through hole diameter		mm (inch)	115 (4.5)	
	Min. spindle indexing angle (C-axis)		deg	-	0.001
Turret	No. of tool stations		st	12	12 {24}*
	OD tool size		mm (inch)	25 (1.0)	25 {20} (1.0 {0.8})*
	Boring bar diameter		mm (inch)	50 (2.0)	50 {40} (2.0 {1.6})*
	Indexing time (1st swivel time)		s	0.15	
	Rotary tool spindle speed		r/min	-	5000
Tail stock	Quill diameter		mm (inch)	100 (3.9)	
	Quill bore taper (Live)			MT#5	
	Compressed air supply		mm (inch)	100 (3.9)	
Sub-spindle	Spindle speed (Belt [Built-in])		r/min	4500	
	Spindle nose			ASA A2#5	
	Spindle bearing diameter (Front)		mm (inch)	90 (3.5)	
	Spindle through hole diameter		mm (inch)	62 (2.4)	
	Min. spindle indexing angle (C-axis)		deg	0.001	
Motors	Main spindle motor		kW (Hp)	22 / 18.5 (30 / 25)	
	Sub spindle motor		kW (Hp)	7.5 / 5.5 (10 / 7)	
	Rotary tool spindle motor		kW (Hp)	-	5.5 (7)
	Coolant pump motor		kW (Hp)	0.4 (0)	
Power source	Electric power supply (Rated capacity)		kVA	48.86	
Machine size	Machine height		mm (inch)	1900 (74.8)	
	Machine dimension	length	mm (inch)	3700 (145.7)	
		width	mm (inch)	1863 (73.3)	
	Machine weight		kg (lb)	5950 (13117.3)	6100 (13448.0)

* []: Option

* The specifications and information above-mentioned may be changed without prior notice.

* For more details, please contact Doosan.

Machine Specifications

PUMA 3100 series

Description		Unit	PUMA 3100 /L/XL/UL	PUMA 3100 M/LM/XLM/ULM	PUMA 3100 Y/LY/XLY(B)/ULY(B)	
Capacity	Swing over bed	mm (inch)	850 (33.5)			
	Swing over front door	mm (inch)	720 (28.3)** / 850 (33.5)***			
	Swing over saddle*	mm (inch)	670 (26.4)			
	Recom. Turning diameter	mm (inch)	315 (12.4)		315 (12.4) (XLYB/ULYB : 380(15.0))	
	Max. turning diameter	mm (inch)	525 (20.7)	420 (16.5)		
	Max. turning length	mm (inch)	790 / 1310 / 2150 / 3150 (31.1 / 51.6 / 84.6 / 124.0)	765 / 1285 / 2125 / 3125 (30.1 / 50.6 / 83.7 / 123.0)		
	Bar working diameter	mm (inch)	102 (4.0)		102 (4.0) (XLYB/ULYB : 116.5(4.6))	
Travels	Travel distance	X-axis	mm (inch)	293 {30.5+262.5} (11.5 {1.2+10.3})*	293 {83+210} (11.5 {3.3+8.3})*	
		Z-axis	mm (inch)	830 / 1350 / 2190 / 3190(32.7 / 53.1 / 86.2 / 125.6)		
		Y-axis	mm (inch)	-	130 (±65) (5.1 (±2.6))	
		B-axis	mm (inch)	-		
Feedrates	Rapid traverse	X-axis	m/min (ipm)	30 (1181.1)		
		Z-axis	m/min (ipm)	30 / 30 / 30 / 26 (1181.1 / 1181.1 / 1181.1 / 1023.6)		
		Y-axis	m/min (ipm)	-	10 (393.7)	
		B-axis	m/min (ipm)	-		
Spindle	Spindle speed (Belt Type)	r/min	2800		2800 (XLYB/ULYB : 2000)	
	Spindle speed (Built-in Type)	r/min	3000		3000 (XLYB/ULYB : N/A)	
	Spindle nose		ASA A2#11			
	Spindle bearing diameter (Front)	mm (inch)	160 (6.3)		160 (6.3) (XLYB/ULYB : 180(7.1))	
	Spindle through hole diameter	mm (inch)	115 (4.5)		115 (4.5) (XLYB/ULYB : 132(5.2))	
	Min. spindle indexing angle (C-axis)	deg	0.001			
Turret	No. of tool stations	st	10	12		
	OD tool size	mm (inch)	25 (1.0)			
	Boring bar diameter	mm (inch)	50 (2.0)			
	Indexing time (1st swivel time)	s	0.15			
	Rotary tool spindle speed	r/min	-	5000		
Tail stock	Quill diameter	mm (inch)	100 / 100 / 120 / 120 (3.9 / 3.9 / 4.7 / 4.7)			
	Quill bore taper (Live)		MT#5			
	Compressed air supply	mm (inch)	100 / 100 / 120 / 120 (3.9 / 3.9 / 4.7 / 4.7)			
Sub-spindle	Spindle speed (Belt [Built-in])	r/min	-			
	Spindle nose		-			
	Spindle bearing diameter (Front)	mm (inch)	-			
	Spindle through hole diameter	mm (inch)	-			
	Min. spindle indexing angle (C-axis)	deg	-			
Motors	Main spindle motor	kW (Hp)	22 / 18.5 (30 / 25)		22 / 18.5 (30 / 25) (XLYB/ULYB : 30/22 (40/30))	
	Sub spindle motor	kW (Hp)	-			
	Rotary tool spindle motor	kW (Hp)	7.5 / 5.5 (7 / 10)			
	Coolant pump motor	kW (Hp)	-	5.5 {7.5} (7 {10})		
Power source	Electric power supply (Rated capacity)	kVA	41.64 / 41.64 / 42.83 / 42.83	44.42 / 44.42 / 45.61 / 45.61	46.40 / 46.40 / 47.59 / 47.59 (XLYB/ULYB : 55.81)	
Machine size	Machine height	mm (inch)	2020 / 2020 / 2315 / 2315 (79.5 / 79.5 / 91.1 / 91.1)		2315 (91.1)	
	Machine dimension	length	mm (inch)	3910 / 4530 / 5615 / 6585 (153.9 / 178.3 / 221.1 / 259.3) (XLYB : 5857 (230.6), ULYB : 6827 (268.8))		
		width	mm (inch)	2002 / 2105 / 2280 / 2280 (78.8 / 82.9 / 89.8 / 89.8)		
	Machine weight	kg (lb)	5850 / 7350 / 10150 / 11650 (12896.9 / 16203.7 / 22376.6 / 23683.5)	6000 / 7500 / 10300 / 11800 (13227.5 / 16534.4/22707.3 / 26014.4)	6500 / 8000 / 10800 / 12300 (14329.8 / 17636.7 / 23809.6 / 27116.5) (XLYB : 11000(24250.5), ULYB : 12500(27557.4))	

* The specifications and information above-ntioned may be changed without prior notice.

** : PUMA 3100/M/L/LM/Y/LY

*** : PUMA 3100XL/UL/XLM/ULM/XLY/ULY

{ } : Option

* For more details, please contact Doosan.

NC Unit Specifications

● Standard ○ Optional X Not applicable

Basic information

Basic Structure
Cutting
Performance

Detailed Information

Options
Applications
Capacity Diagram
Specifications

Customer Support Service



NO.	Division	Item	Spec.	DOOSAN Fanuc i Plus						Fanuc 31i	
				2-Axis	M	MS	Y	SY	S	Y	SY
1	Controlled axis	Controlled axes		2 (X,Z)	3 (X,Z,C)	4 (X,Z,C,B)	4(X,Z,C,Y)	6 (X,Z,C1,Y,C2,B)	3 (X,Z,B)	4 (X,Z,C,Y)	6 (X,Z,C1,Y,C2,B)
2		Cs contouring control		X	●	●	●	●	X	●	●
3		Synchronous / Composite control (C1 & C2 Synchro Control)		X	X	●	X	●	X	X	●
4		Torque control		●	●	●	●	●	●	●	●
5		HRV2 control		●	●	●	●	●	●	●	●
6		Inch / metric conversion		●	●	●	●	●	●	●	●
7		Stored limit check before move		●	●	●	●	●	●	○	○
8		Chamfering on / off		●	●	●	●	●	●	●	●
9		Unexpected disturbance torque detection function		●	●	●	●	●	●	●	●
10		Position switch		●	●	●	●	●	●	●	●
11	Operation	DNC operation	Included in RS232C interface.	●	●	●	●	●	●	●	●
12		DNC operation with memory card		●	●	●	●	●	●	●	●
13		Tool retract and recover		○	○	○	○	○	○	○	○
14		Dry run (드라이 런)		●	●	●	●	●	●	●	●
15		Single block (싱글 블록)		●	●	●	●	●	●	●	●
16		Handle interruption		○	○	○	○	○	○	○	○
17		Incremental feed	x1,x10,x100	●	●	●	●	●	●	●	●
18		Manual handle retrace		○	○	○	○	○	○	○	○
19		Active block cancel		○	○	○	○	○	○	○	○
20		Interpolation functions	Nano interpolation		●	●	●	●	●	●	●
21	Linear interpolation			●	●	●	●	●	●	●	●
22	Circular interpolation			●	●	●	●	●	●	●	●
23	Polar coordinate interpolation			X	●	●	●	●	X	●	●
24	Cylindrical interpolation			X	●	●	●	●	X	●	●
25	Helical interpolation			X	○	○	●	●	X	●	●
26	Thread cutting, synchronous cutting			●	●	●	●	●	●	●	●
27	Multi threading			●	●	●	●	●	●	●	●
28	Thread cutting retract			●	●	●	●	●	●	●	●
29	Continuous threading			●	●	●	●	●	●	●	●
30	Variable lead thread cutting		●	●	●	●	●	●	○	○	
31	Circular thread cutting		○	○	○	○	○	○	○	○	
32	Polygon machining with two spindles		X	●	●	●	●	X	○	○	
33	High-speed skip	Input signal is 8 points.	○	○	○	○	○	○	○	○	
34	2nd reference position return	G30	●	●	●	●	●	●	●	●	
35	3rd/4th reference position return		●	●	●	●	●	●	○	○	
36	Feed function	Override cancel		●	●	●	●	●	●	●	●
37		AI contour control I		○	○	○	●	●	○	●	●
38		AI contour control II		○	○	○	○	○	○	○	○
39	Rapid traverse block overlap		●	●	●	●	●	●	●	●	
40	Program input	Optional block skip	9 pieces	●	●	●	●	●	●	●	●
41		Absolute / incremental programming	Combined use in the same block	●	●	●	●	●	●	●	●
42		Diameter / Radius programming		●	●	●	●	●	●	●	●
43		Automatic coordinate system setting		●	●	●	●	●	●	●	●
44		Workpiece coordinate system	G52 - G59	●	●	●	●	●	●	●	●
45		Workpiece coordinate system preset		●	●	●	●	●	●	○	○
46		Addition of workpiece coordinate system	48 pairs	X	X	X	X	X	X	○	○
47	Direct drawing dimension programming		●	●	●	●	●	●	●	●	

● Standard ○ Optional X Not applicable

NO.	Division	Item	Spec.	DOOSAN Fanuc i Plus						Fanuc 31i	
				2-Axis	M	MS	Y	SY	S	Y	SY
48	Program input	G code system	A	●	●	●	●	●	●	●	●
49		G code system	B/C	●	●	●	●	●	●	●	●
50		Chamfering / Corner R		●	●	●	●	●	●	○	○
51		Custom macro		●	●	●	●	●	●	●	●
52		Addition of custom macro common variables	#100 - #199, #500 - #999	●	●	●	●	●	●	○	○
53		Interruption type custom macro		●	●	●	●	●	●	○	○
54		Canned cycle		●	●	●	●	●	●	●	●
55		Multiple repetitive cycles	G70~G76	●	●	●	●	●	●	●	●
56		Multiple repetitive cycles II	Pocket profile	●	●	●	●	●	●	●	●
57		Canned cycle for drilling		●	●	●	●	●	●	●	●
58		Automatic corner override		X	X	X	X	X	X	○	○
59		Coordinate system shift		●	●	●	●	●	●	●	●
60		Direct input of coordinate system shift		●	●	●	●	●	●	●	●
61		Pattern data input		●	●	●	●	●	●	○	○
62	Operation Guidance Function	EZ Guidei (Conversational Programming Solution)		●*1	●*1	●*1	●*1	●*1	●*1	●	●
63		iHMI with Machining Cycle		○*2	○*2	○*2	○*2	○*2	○*2	X	X
64		EZ Operation package		●	●	●	●	●	●	●	●
65	Auxiliary / Spindle speed function	Constant surface speed control		●	●	●	●	●	●	●	●
66		Spindle override (스핀들 속도오버라이드)	0 - 150%	●	●	●	●	●	●	●	●
67		Spindle orientation (스핀들 오리엔테이션)		●	●	●	●	●	●	●	●
68		Spindle synchronous control		X	X	●	X	●	●	X	●
69		Rigid tap		●	●	●	●	●	●	●	●
70	Arbitrary speed threading		○	○	○	○	○	○	○	○	
71	Tool function / Tool compensation	Tool offset pairs	32-pairs	X	X	X	X	X	X	●	●
72			64-pairs	X	X	X	X	X	X	○	○
73			99-pairs	X	X	X	X	X	X	○	○
74			128-pairs	●	●	●	●	●	●	X	X
75			200-pairs	○	○	○	○	○	○	○	○
76			400 / 499 / 999-pairs	X	X	X	X	X	X	○	○
77		Tool offset		●	●	●	●	●	●	●	●
78		Tool radius/Tool nose radius compensation		●	●	●	●	●	●	●	●
79	Tool geometry / wear compensation		●	●	●	●	●	●	●	●	
80	Automatic tool offset	G36/G37	●	●	●	●	●	●	●	●	
81	Direct input of offset value measured B		●	●	●	●	●	●	●	●	
82	Tool life management		●	●	●	●	●	●	●	●	
83	Accuracy compensation function	Backlash compensation for each rapid traverse and cutting feed		●	●	●	●	●	●	●	●
84		Stored pitch error compensation		○	○	○	○	○	○	○	○
85	Editing operation	Part program storage size & Number of registerable programs	640M(256KB)_500 programs	X	X	X	X	X	X	●	●
86			1280M(512KB) / 2560M(1MB) / 10240M(4MB) / 20480M(8MB)_1000 programs	X	X	X	X	X	X	○	○
87			5120M(2MB)_1000 programs	●	●	●	●	●	●	○	○
92			2560M(1MB)_2000, 5120M(2MB) / 10240M(4MB) / 20480M(8MB)_4000 programs	X	X	X	X	X	X	○	○
93	Program protect		●	●	●	●	●	●	●	●	
94	Password function		●	●	●	●	●	●	●	●	
95	Playback		●	●	●	●	●	●	○	○	
96	Data input / output	Fast data server		○	○	○	○	○	○	○	○
97		External data input		●	●	●	●	●	●	○	○
98		Memory card input / output		●	●	●	●	●	●	●	●
99		USB memory input / output		●	●	●	●	●	●	●	●
100	Automatic data backup		●	●	●	●	●	●	●	●	
101	Interface function	Embedded Ethernet		●	●	●	●	●	●	●	●
102		Fast Ethernet		○	○	○	○	○	○	○	○
103	Others	Display unit	15" color LCD	●	●	●	●	●	●	●	●
104			15" color LCD with Touch Panel	○	○	○	○	○	○	X	X
105	Robot interface	with PMC I/O module		○	○	○	○	○	○	○	○
106		with PROFIBUS-DP		○	○	○	○	○	○	○	○

*1) Only with 15" LCD standard *2) Only with 15" Touch LCD standard

Basic information

Basic Structure
Cutting
Performance

Detailed Information

Options
Applications
Capacity Diagram
Specifications

Customer Support Service



No.	ITEM	Spec.	S828D
1	Controlled axes	2 axis	X, Z, SP
2	R: Milling spindle	M-type	X, Z, C, R
3	Simultaneously controlled axes	Positioning(G00)/Linear interpolation(G01) : 3 axes Circular interpolation(G02, G03) : 2 axes	●
4	Backlash compensation		●
5	Leadscrew error compensation		●
6	Measuring system error compensation		●
7	Feedforward control	velocity-dependent	●
8	Follow up mode		●
9	Programmable acceleration		●
10	Emergency stop / overtravel		●
11	Least command increment	0.001mm (0.0001 inch)	●
12	Least input increment	0.001mm (0.0001 inch)	●
13	Maximum commandable value	±99999.999mm (±3937 inch)	●
14	Machine lock (PRT)		●
15	Absolute encoder		●
16	Dry run		●
17	Feedrate/Rapid override	0 - 120 %	●
18	Reference point return	G75 FP=1	●
19	2nd reference point return	G75 FP=2	●
20	3rd / 4th reference return	G75 FP=3, 4	●
21	Linear interpolation	Max. 4	●
22	Circular interpolation	G02, G03	●
23	Inverse time feedrate	G93	●
24	Helical interpolation		●
25	Universal interpolator NURBS		●
26	Spline interpolation (A, B and C splines)		○
27	Dwell	G04	●
28	Separate path feed for corners and chamfers		●
29	Reposition		●
30	Acceleration with Jerklimitation		●
31	Positioning	G00	●
32	Cartesian point-to-point (PTP) travel		●
33	TRANSMIT/cylinder surface transformation	Not available for 2-axis type	●
34	Inclined axis	If machine attached inclind Y axis	●
35	Inclined axis TRAANG after TRANSMIT/TRACYL	If machine attached inclind Y axis	●
36	Couplings	CP-Basic(if machine attached milling spindle) CP-Comfort	● ○
38	Spindle speed, digital setpoint		●
39	Spindle speed, max. programmable value range	106 ... 0.0001 (display: ± 999999999.9999)	●
40	Spindle override	50 - 120 %	●
41	Automatic gear state selection		●
42	Oriented spindle stop		●
43	Spindle speed limitation min./max.		●
44	Constant cutting rate		●
45	Spindle control via PLC (Positioning, oscillation)		●
46	Changeover to axis mode		●
47	Tapping with compensating chuck/rigid tapping		●
48	Retraction for rigid tapping		●
49	Tool radius compensations in plane		●
50	• With approach and retract strategies		●
51	• With transition circle/ellipse on outer edges		●
52	Number of tools/cutting edges in tool list	PPU.4 for S828D SW261 (2 axis/M-type)	256/512
53		PPU.4 for S828D SW281 (S/MS/Y/SY-type)	768/1536
54	Tool length compensation		●
55	Operation with tool management		●
56	Tool list		●
57	Tool offset selection via T and D numbers		●
58	Replacement tools for tool management	Include tool load monitoring option	○
59	Monitoring of tool life and workpiece count		●
60	Manual measurement of tool offset		●
61	Magazine list		●
62	Loading and unloading of tools		●
63	Number of subroutine passes <= 9999		●
64	Number of levels for skip blocks 1		●
65	Number of levels for skip blocks 8		○
66	Polar coordinates		●
67	1/2/3-point contours		●
68	Dimensions metric/inch, changeover manually or via program		●

● Standard ○ Optional X Not applicable

No.	ITEM	Spec.	S828D
69	Program functions		
70	• Dynamic preprocessing memory FIFO		●
71	• Look ahead number of blocks	In 840D, If machine attached milling spindle	1
72	• Frame concept		●
73	• Inclined-surface machining with swivel cycle		●
74	• Axis/spindle replacement		●
75	• Geometry axes, switchable online in the CNC program		●
76	• Program preprocessing		●
77	Online ISO dialect interpreter		●
78	Program/workpiece management		
73	• Parts programs on NCU, max. number		750
74	• Workpieces on NCU, max. number		250
75	• On USB storage medium (e.g. disk drive, USB stick)		●
76	• On network drive		○
77	Settable offsets, max. number	G54, G55, G56 ...	100
78	Program editor		
79	• Programming support for cycles program(Program Guide)		●
80	• CNC editor with editing functions: Marking, copying, deleting		●
81	• Programming graphics/free contour input (contour calculator)		●
82	• Support for parameter input Animated Elements		●
83	• ShopTurn/ShopMill Machining step programming		●
84	Technology cycles for drilling/milling		●
85	Pocket milling free contour and islands stock removal cycle		●
86	Residual material detection		●
87	Access protection for cycles		●
88	Programming support can be extended, e.g. customer cycles		●
89	2D simulation		●
90	3D simulation, finished part		●
91	Simultaneous recording		●
92	JOG		
93	• Handwheel selection		●
94	• Switchover: inch/metric		●
95	• Manual measurement of zero/work offset		●
96	• Manual measurement of tool offset		●
97	• Automatic tool/workpiece measurement		●
98	• Reference point approach, automatic/via CNC program		●
99	Automatic		
100	• Execution from USB or CF card interface on operator panel front		●
101	• Execution from HMI memory on NCU CF card	In 840D, If machine attached milling spindle	X
102	• Execution from network drive		○
103	Operating software languages		
104	• Ch_S, Ch_T, En, Fr, Gr, It, Kr, Pt, Sp		●
105	• Additional languages, use of language extensions		●
106	Working area limitation		●
107	Limit switch monitoring		●
108	Software and hardware limit switches		●
109	Position monitoring		●
110	Standstill (zero-speed) monitoring		●
111	Clamping monitoring		●
112	2D/3D protection zones		●
113	Contour monitoring		●
114	Axis limitation from the PLC		●
115	Alarms and messages		●
116	Action log can be activated for diagnostic purposes		●
117	PLC status		●
118	Remote Control System (RCS) remote diagnostics		
119	• RCS Host remote diagnostics function		○
120	• RCS Commander (viewer function)	RCS Commander for PC/PG on CD-ROM	●
121	Integrated service planner for the monitoring of service intervals		●
122	Measuring, Measuring stage 1 Two probes (switching) with/without deletion of distance-to-go	Measurement probe & receiver is needed	●
123	Measuring cycles for drilling/milling and turning • Calibrating workpiece probes • Workpiece measurement • Tool measuring	Measurement probe & receiver is needed (included in MDynamics 3-axis & 5-axis) In 840D, If machine attached milling spindle	○
124	Easy Extend		●
125	Contour handwheel		●
126	Integrate screens in SINUMERIK Operate with SINUMERIK Integrate Run MyScreens		●
127	Cross-mode actions (ASUPs and synchronized actions in all operating modes)		○

Responding to Customers Anytime, Anywhere

Doosan Machine Tools' Global Network, Responding to Customer's Needs nearby, Anytime, Anywhere

Doosan machine tools provides a system-based professional support service before and after the machine tool sale by responding quickly and efficiently to customers' demands.

By supplying spare parts, product training, field service and technical support, we can provide top class support to our customers around the world.



Global Sales and Service Support Network

Corporations	Dealer Networks	Technical Centers Technical Center: Sales Support, Service Support, Parts Support	Service Post	Factories
4	167	51	200	3

Doosan Machine Tools Customer Support Service

We help customers to achieve success by providing a variety of professional services from pre-sales consultancy to post-sales support.



Supplying Parts

- Supplying a wide range of original Doosan spare parts
- Parts repair service



Field Services

- On site service
- Machine installation and testing
- Scheduled preventive maintenance
- Machine repair



Technical Support

- Supports machining methods and technology
- Responds to technical queries
- Provides technical consultancy



Training

- Programming / machine setup and operation
- Electrical and mechanical maintenance
- Applications engineering



Major Specifications

PUMA 2100 / 2600 / 3100 series



Description	Unit	PUMA 2100	PUMA 2600	PUMA 2600B	PUMA 3100
Max. turning diameter (2axis / M&Y)	mm (inch)	481 / 406 (18.9 / 16.0)	481 / 376 (18.9 / 14.8)	481 / 376 (18.9 / 14.8)	525 / 420 (20.7 / 16.5)
Max. turning length*	mm (inch)	500 / 750 (19.7 / 29.5)	500 / 750 / 1250 (19.7 / 29.5 / 49.2)	750 / 1250 (29.5 / 49.2)	750 / 1250 / 2000 / 3000 (29.5 / 49.2 / 78.7 / 118.1)
Chuck size	inch	8	10	12	12 {XLYB / ULYB : 15}
Bar working diameter	mm (inch)	65 (2.6)	76 (3.0)	102 (4.0)	102 (4.0)
Max. spindle speed	r/min	4500	3500	2800	2800

* approximate value

Doosan Machine Tools

www.doosanmachinetools.com



Head Office

22FT Tower, 30, Sowol-ro 2-gil, Jung-gu, Seoul, Korea, 04637

Tel +82-2-6972-0370 / 0350

Fax +82-2-6972-0400

Doosan Machine Tools America

19A Chapin Rd., Pine Brook, NJ 07058, U.S.A.

Tel +1-973-618-2500

Fax +1-973-618-2501

Doosan Machine Tools Europe

Emdener Strasse 24, D-41540 Dormagen, Germany

Tel +49-2133-5067-100

Fax +49-2133-5067-111

Doosan Machine Tools India

No.82, Jakkuar Village, Yelahanka Hobli, Bangalore-560064

Tel + 91-80-2205-6900

E-mail india@doosanmt.com

Doosan Machine Tools China

Room 101,201,301, Building 39 Xinzhuang Highway No.258 Songjiang District, China Shanghai(201612)

Tel +86 21-5445-1155

Fax +86 21-6405-1472

* For more details, please contact Doosan Machine Tools.

* The specifications and information above-mentioned may be changed without prior notice.

* Doosan Machine Tools Co., Ltd. is a subsidiary of MBK Partners. The trademark **DOOSAN** is used under a licensing agreement with Doosan Corporation, the registered trademark holder.

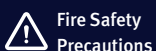

Fire Safety Precautions

There is a high risk of fire when using non-water-soluble cutting fluids, processing flammable materials, neglecting use coolants and modifying the machine without the consent of the manufacturer. Please check the SAFETY GUIDANCE carefully before using the machine.

ver. EN 200819 SU